

# Digital detector - Dual Tech

Catalogue number(s): 488 22

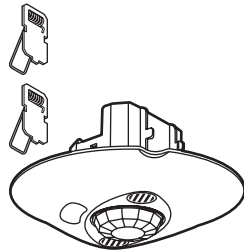

## CONTENTS

Page

1. Use.....	1
2. Technical features.....	1
3. Overall dimensions.....	1
4. Connection.....	2
5. Installation.....	2
6. Disassembly.....	2
7. Settings.....	3
8. Performance.....	4
9. Maintenance.....	4
10. Standards.....	4

### 1. USE

This device allows a light source to be controlled automatically via a controller through the detection of movement in its surveillance zone.

Movement detector with detection angle of 360°.  
Detection type: infra-red (PIR) and ultrasound (US)  
Assembly type: ceiling

### 2. TECHNICAL FEATURES

Voltage: 27 V=  
No load power consumption: 17 mA  
Connection between detector and actuator: RJ 45 lead or cable or BUS/SCS cable to be fitted with RJ 45 connector  
Flush-mounting diameter: 65 mm without flush-mounting box, 68 mm with flush-mounting box  
Weight: 150 g  
Impact resistance: IK04  
Penetration by solid and liquid matter: IP20  
Usage temperature: -5°C to +45°C  
Storage temperature: -20°C to +70°C

#### Cover removed

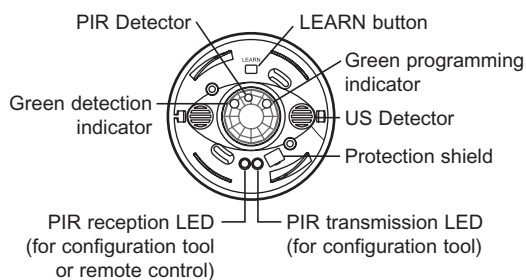

### 3. OVERALL DIMENSIONS

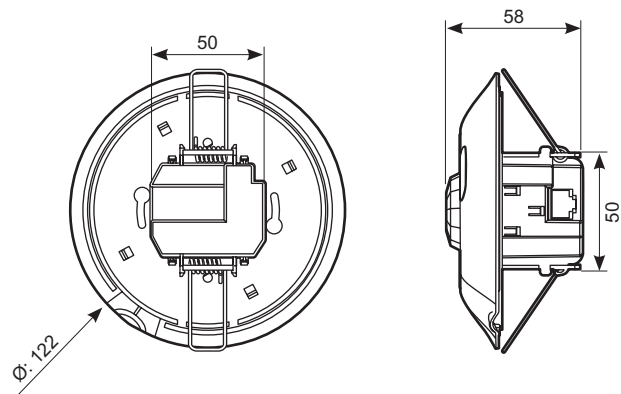

## 4. CONNECTION

Type of terminals: RJ 45

RJ 45

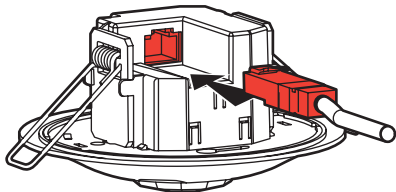

RJ 45 patch and equipment cords

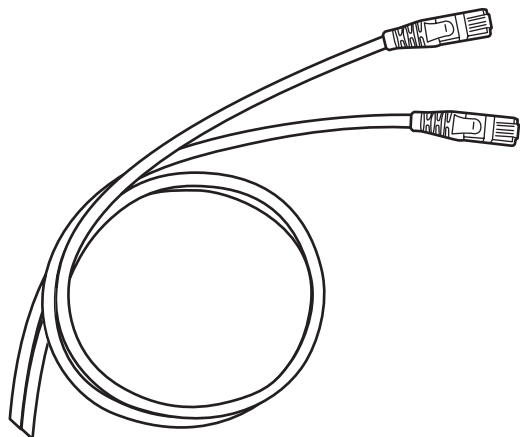

RJ 45 - BUS/SCS connector

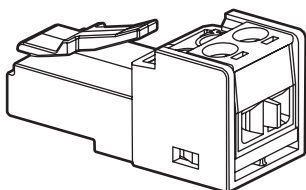

RJ 45 doubler

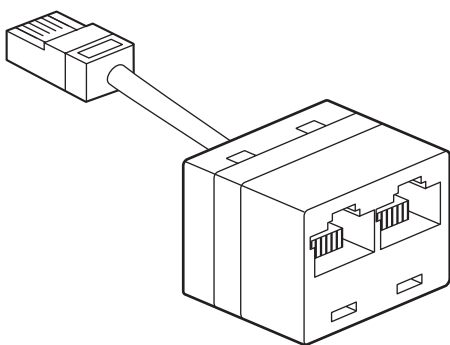

**Option:** It is possible to manage the detector by infra-red remote control.

## 5. INSTALLATION

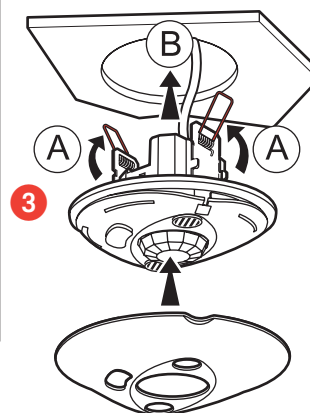
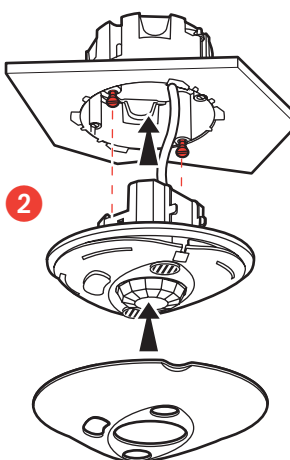
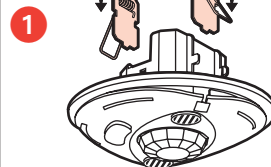
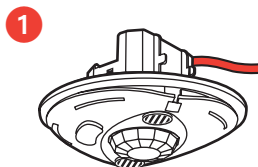
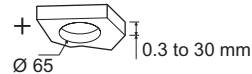
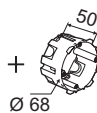

## 6. DISASSEMBLY

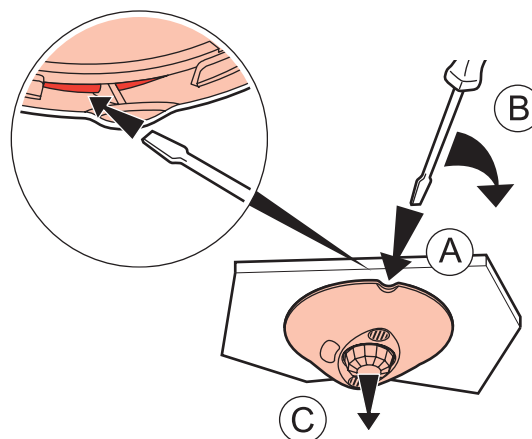

## 7. SETTINGS

### - Parameters:

Detection parameters		Default value	Modifiable parameters	Configuration tools	
				88230	88235
Time delay		15 mins	3,5,10,15,20 mins	-	✓
			30s - 255 h 59 min 59s	✓	-
Sensitivity	US (high)	PIR (very high)	Low, medium, high, very high	✓	✓
Daylight setpoint	500 lux		20, 100, 300, 500, 1000 lux	-	✓
			0 - 1275 lux	✓	-
Modes	Auto on/Auto off	Inactive	Enabled/Disabled	✓	✓
	Walkthrough	Active	Enabled/Disabled	✓	✓
	Manual on/Auto off	Inactive	Enabled/Disabled	✓	✓
	Partial on/Group off	Inactive	Enabled/Disabled	✓	-
Detection scheme	Initial	PIR and US	PIR and/or US, PIR, US	✓	-
	Maintain	PIR or US	PIR and/or US, PIR, US	✓	-
	Retrigger	PIR or US	PIR and/or US, PIR, US, Disabled	✓	-
Alert		Inactive	Enabled/Disabled	✓	-
Advanced mode	Calibration	-	0 - 99995 lux	✓	-
	Light regulation	Inactive	Enabled/Disabled	✓	-
	Provision of light	Auto	Auto - 1275 lux	✓	-

**Time delay:** Length of time the load is on after a detection is made.

**Sensitivity:** Detection range setting.

**Daylight setpoint:** Value at which the load comes on if light is less than the setting and goes off if it is above this threshold.

#### Auto on/Auto off mode:

Comes on automatically:

- At the detection of a presence if there is an insufficient natural level of light.

Turns off automatically:

- If no presence is detected and at the end of the time delay set.

- Or if there is a sufficient natural level of light (activated setting).

Any new detection causes an automatic switch on if there is insufficient light.

#### Walkthrough:

- If there is no presence detected in the 3 minutes following an initial detection, the product will cut off after 3 minutes.

- If a new presence is detected in the 3 minutes following the initial detection, the device will cut off at the end of the time delay set.

#### Manual on/Auto off mode:

Comes on via a manual switch, automatic switch off:

- Where no presence is detected and at the end of the time delay set.

Following switch-off any new detection within a 30 second period will cause the device to be switched on automatically.

After 30 seconds the device is switched on via a manual switch.

## 7. SETTINGS (continued)

### Partial on/Group off mode:

Possibility of controlling one or more lighting points individually.

In this mode it is essential for a lighting group to be created:

- Either by manual teach phase.

- Or from the advanced configuration tool cat. no. 882 30 by using the function "PnL capteur" (PnL detector).

The detector switches the loads on that are linked to it via the actuator. Where there is no detection and at the end of the time delay it switches off all loads in the group to which it belongs.

**Initial detection:** The load is switched on with the first detection made.

**Maintain:** The load remains active if any new presence is detected.

**Retrigger:** Function allowing automatic start of the product at the end of 30 seconds following the load being switched off.

On being switched off any new detection within a 30 second period will cause the device to be switched on automatically.

After 30 seconds the device must be switched on manually.

**Rating:** The surrounding level of light measured with a luxmeter will then have to be transmitted to the detector.

**Light regulation :** Automatic switch-off of the load 10 minutes after the Daylight setpoint is exceeded. If the level of light is less than the Daylight setpoint, the load is activated automatically after 20 seconds.

**Provision of light:** Quantity of additional lux brought in by the load being switched on.

### - Modification of the parameters by the configuration tools

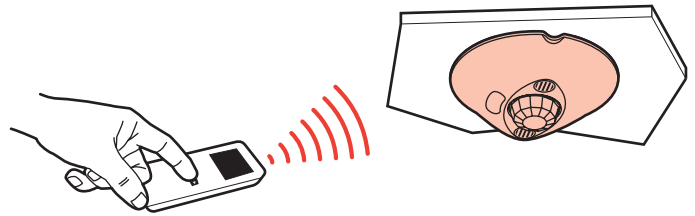

• 882 35: Simplified configuration tool

• 882 30: Advanced configuration tool

When the detector receives an PIR command using the configuration tool it emits a beep acknowledging the modification.

### - Return to factory settings:

1<sup>st</sup> press: Where LEARN is pressed for a short period the LED flashes slowly.

2<sup>nd</sup> press: Keep LEARN pressed down for 10 seconds until the LED flashes quickly.

## 8. PERFORMANCE

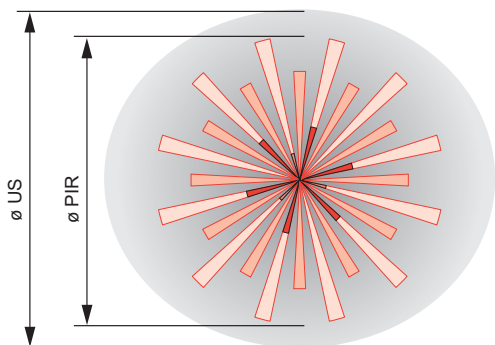
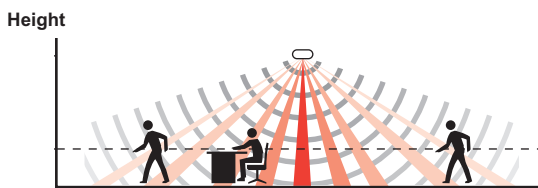

### - PIR Detection

Height (m)	Sensitivity Low (25%)		Sensitivity Medium (50%)	
	Ø (m)	Surface (m <sup>2</sup> )	Ø (m)	Surface (m <sup>2</sup> )
2.5	4	15	6	25
3	5.5	25	6.5	35
4	6.5	35	7.5	45
5	6	30	10.5	90
6	4	15	5.5	25

Height (m)	Sensitivity High (75%)		Sensitivity Very high (100%)	
	Ø (m)	Surface (m <sup>2</sup> )	Ø (m)	Surface (m <sup>2</sup> )
2.5	6.5	30	8	50
3	8.5	60	11.5	100
4	12.5	125	14	155
5	12	115	16.5	215
6	8.5	60	12.5	125

### - US Detection

Height (m)	Sensitivity Low (25%)		Sensitivity Medium (50%)	
	Ø (m)	Surface (m <sup>2</sup> )	Ø (m)	Surface (m <sup>2</sup> )
2.5	4	15	4	15
3	6	30	6	30
4	6	30	6	30
5	6	30	6	30
6	0	0	6	30

Height (m)	Sensitivity High (75%)		Sensitivity Very high (100%)	
	Ø (m)	Surface (m <sup>2</sup> )	Ø (m)	Surface (m <sup>2</sup> )
2.5	6	30	11	95
3	8	50	13	150
4	10	80	13	150
5	10	80	13	130
6	10	80	13	130

## 9. MAINTENANCE

Keep the lens clean.  
 Clean the surface with a cloth.  
 Do not use: acetone, tar-removing cleaning agents or trichloroethylene.  
 Maintenance with the following products: - Hexane (En 60669-1),  
 - Methylated spirit,  
 - Soapy water,  
 - Diluted ammonia,  
 - Bleach diluted to 10%,  
 - Window-cleaning products.

**ATTENTION:** An initial test is required for the use of other special maintenance products.

## 10. STANDARDS

Directive: CE  
 Installation standards: NFC 15-100  
 Product standards: IEC 60669-2-1  
 Environmental standards:  
 - EU Directive 2002/96/EC:  
 WEEE (Waste Electrical and Electronic Equipment)  
 - EU Directive 2002/95/EC:  
 RoHS (Restriction of Hazardous Substances)  
 - Regulations: ERP (public buildings)  
 ERT (workplace buildings)  
 IGH (high-rise buildings)