

# LIVINGLIGHT - 2 MODULE AREA INSTALLATION SYSTEM

## Square cover plates

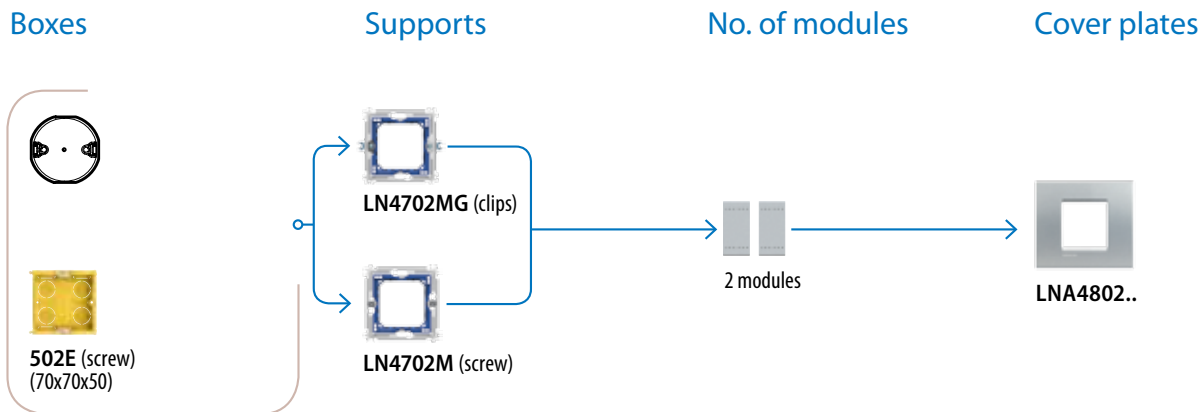

### HORIZONTAL INSTALLATION CENTRE DISTANCE 71 mm

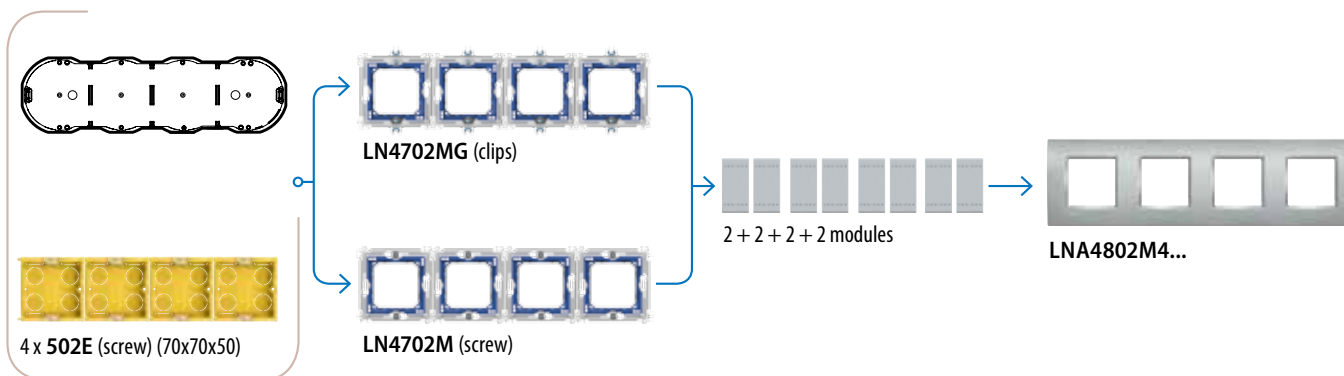
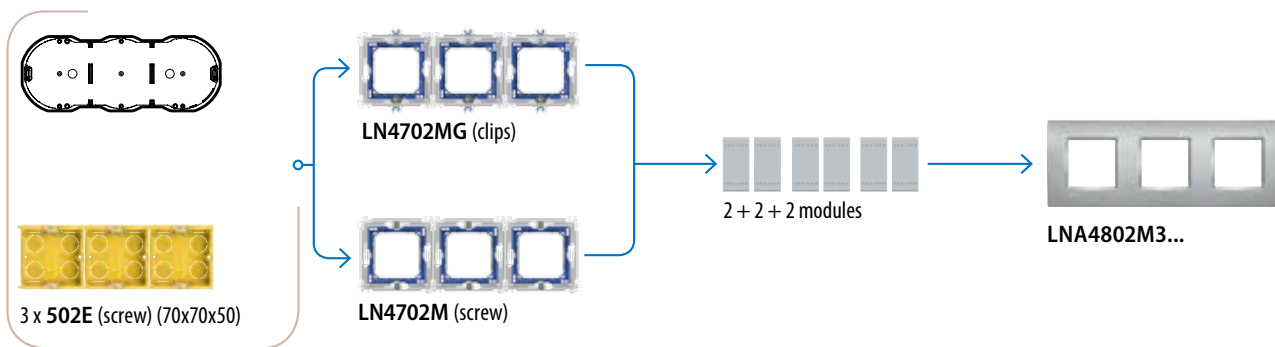
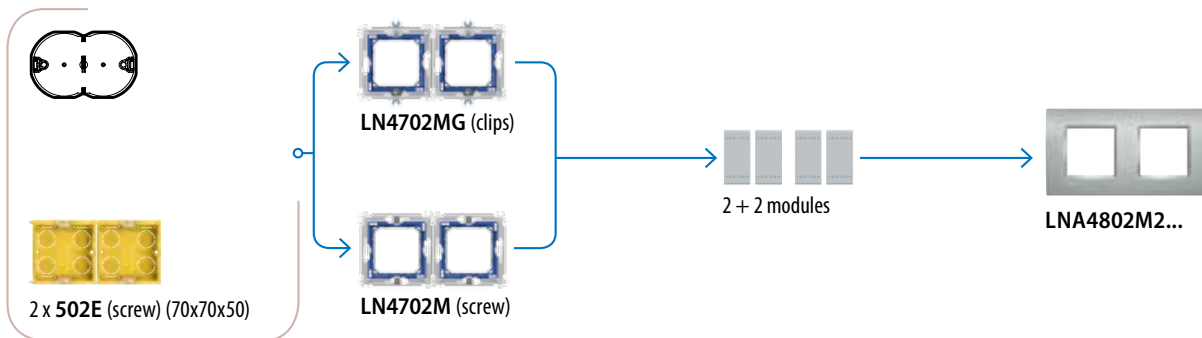

**Note:** The clear protection is supplied as standard with LN4702MG and LN4702M supports, to preserve the integrity of the devices, protecting them from installation dust, paint and scratches during all stages after their installation, and until the cover plates are fitted.

**Boxes**

**Supports**

**No. of modules**

**Cover plates**

**VERTICAL INSTALLATION  
CENTRE DISTANCE 71 mm**

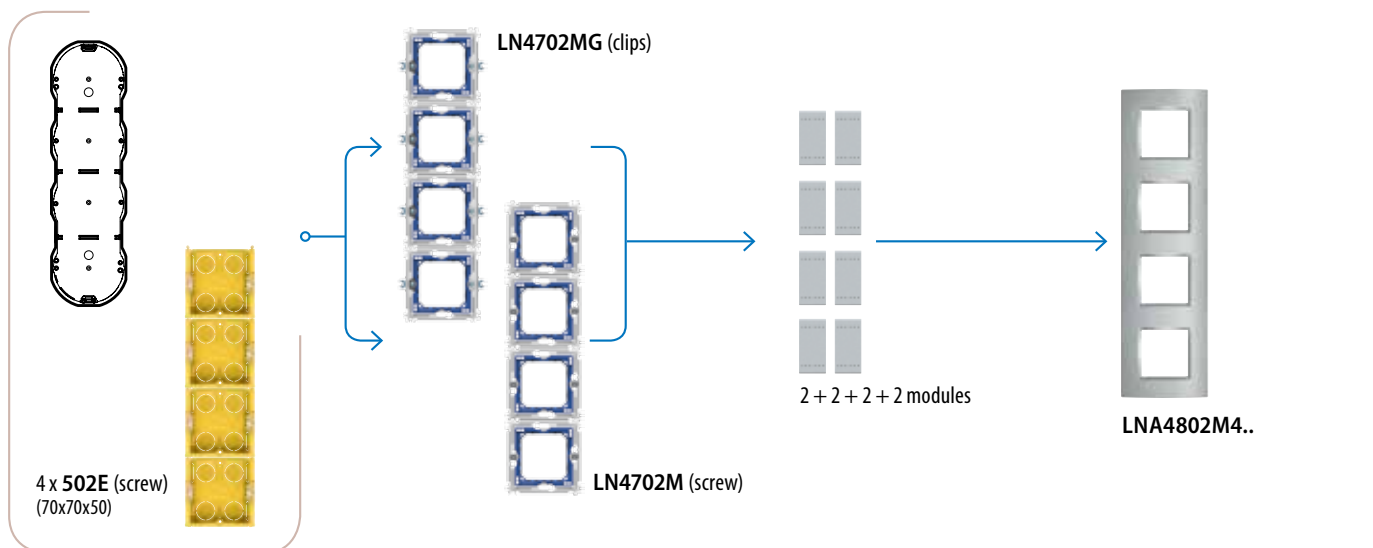
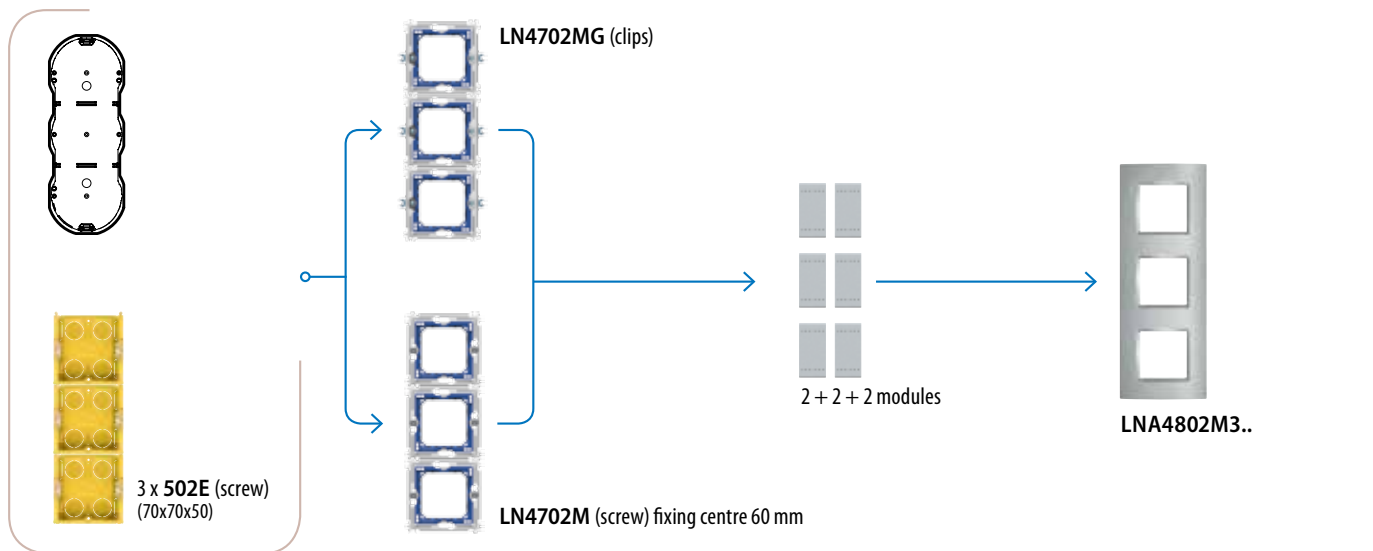
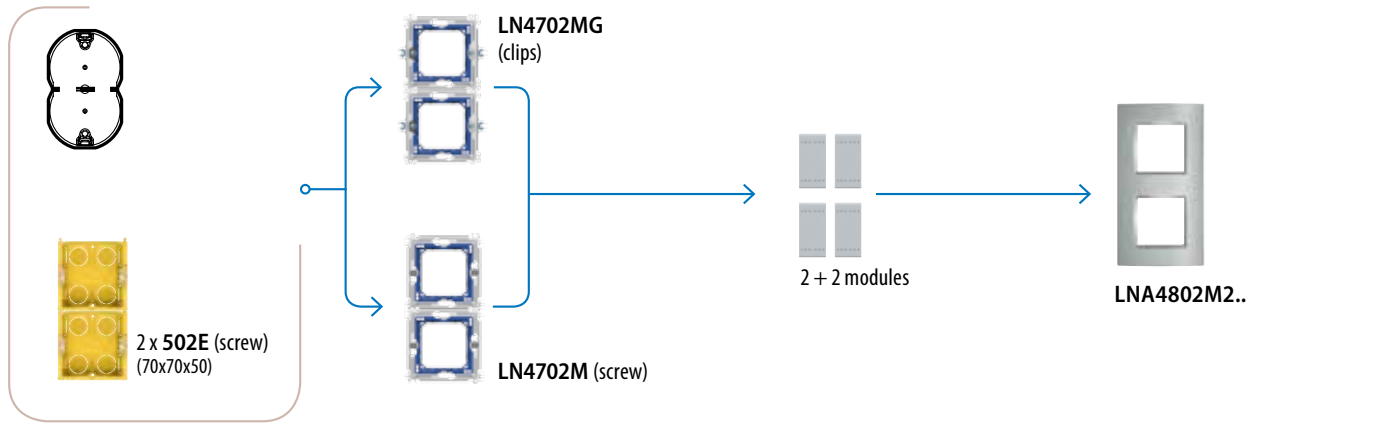

# LIVINGLIGHT - 2 MODULE AREA INSTALLATION SYSTEM

## Square cover plates

Boxes                                  Supports                                  No. of modules                                  Cover plates

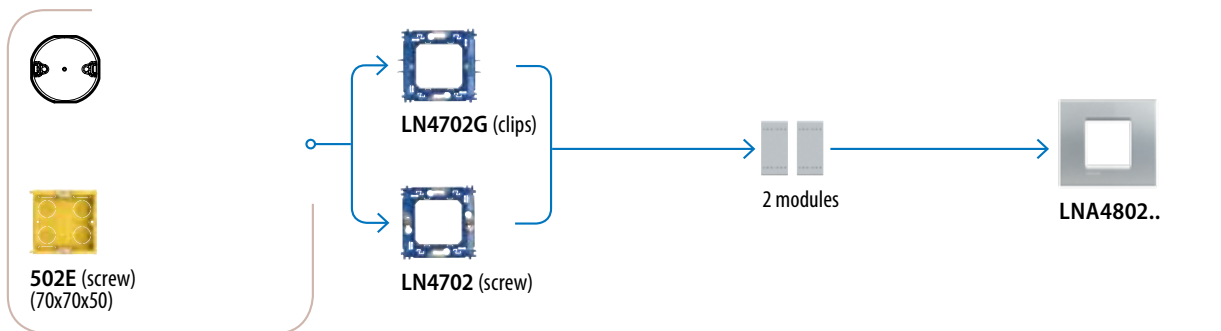

### HORIZONTAL INSTALLATION CENTRE DISTANCE 71 mm

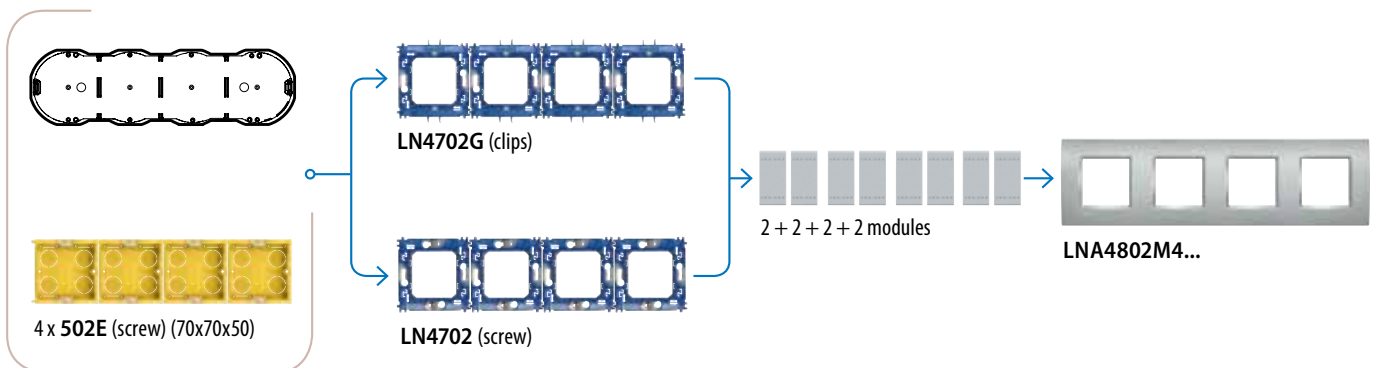
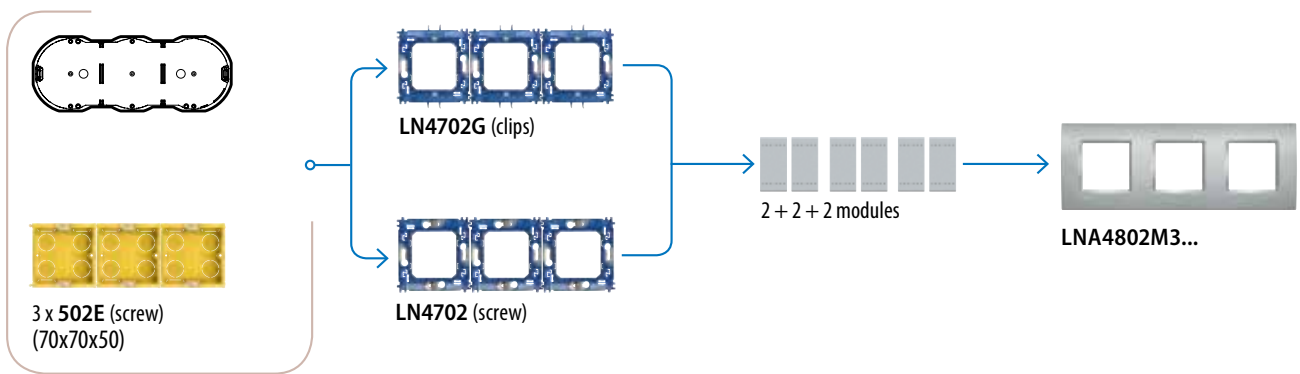
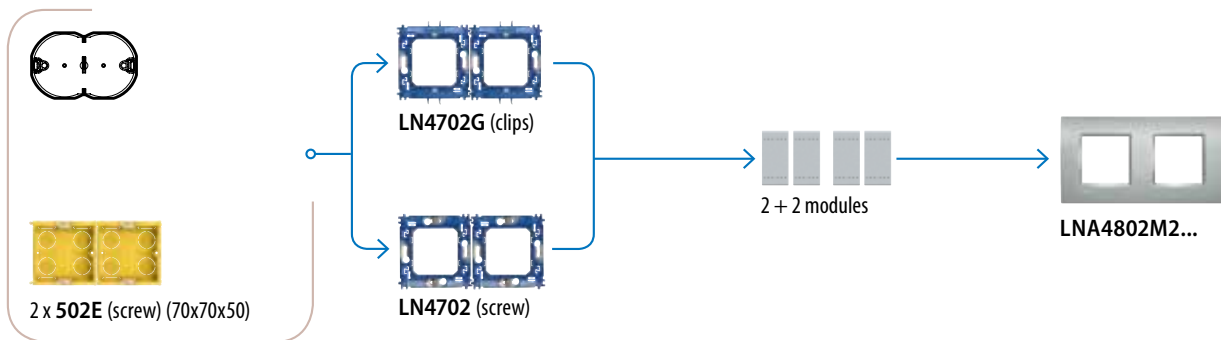

**Boxes**

**Supports**

**No. of modules**

**Cover plates**

**VERTICAL INSTALLATION  
CENTRE DISTANCE 71 mm**

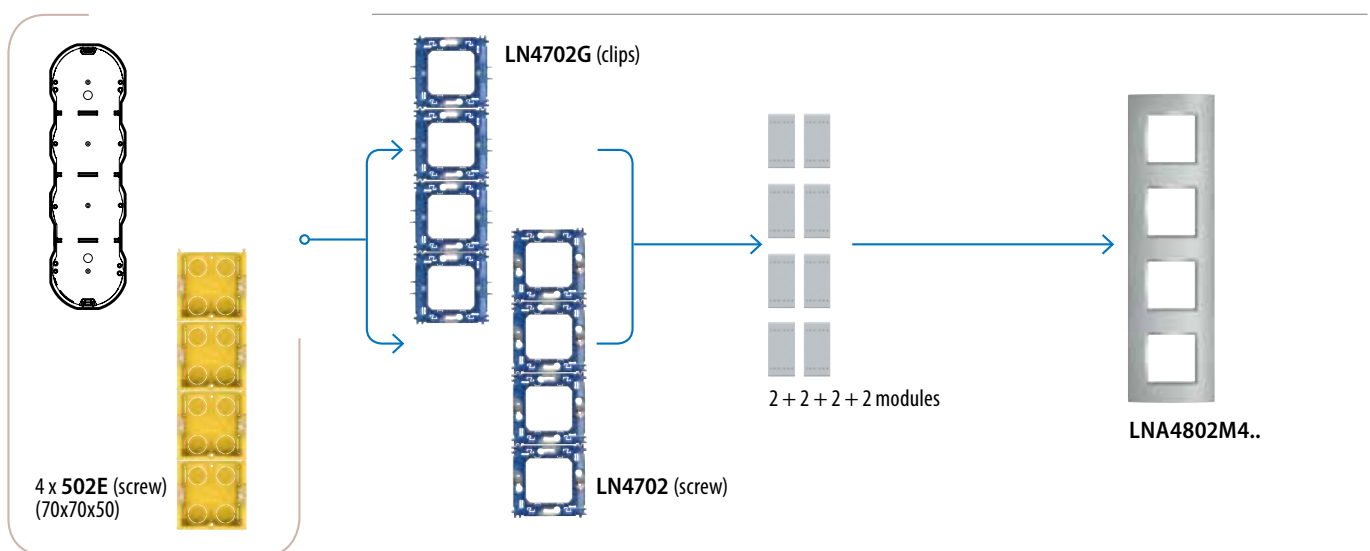
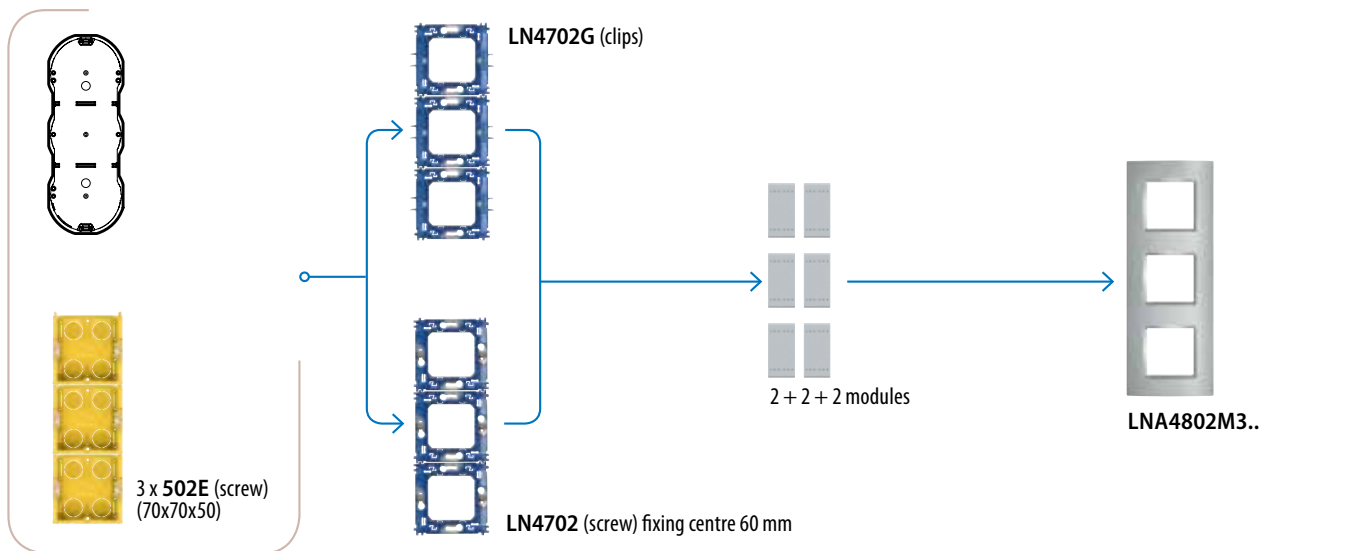
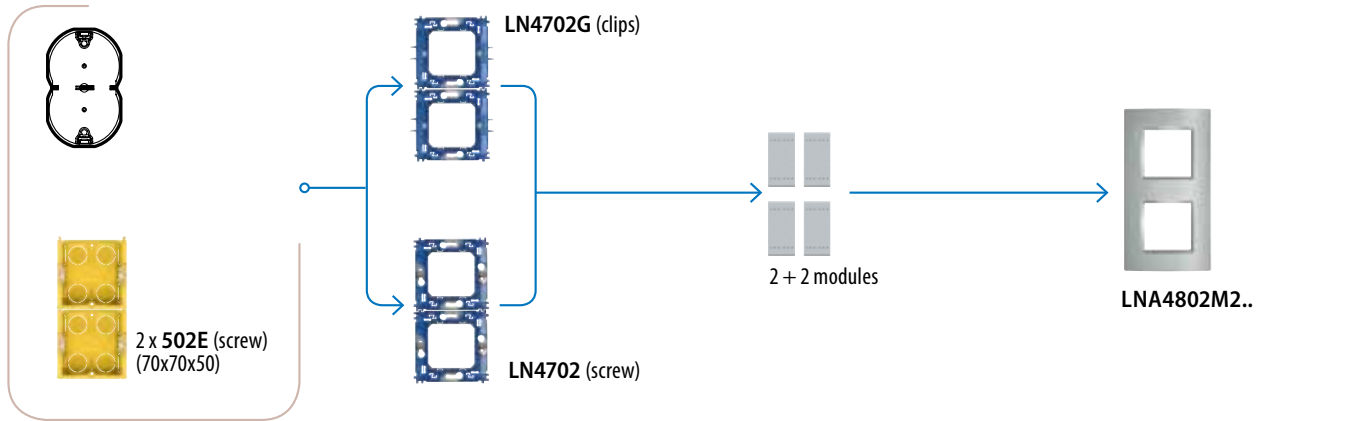

# LIVINGLIGHT - 2 MODULE BELGIAN INSTALLATION SYSTEM

## Square cover plates

Boxes

Supports

No. of modules

Cover plates

**VERTICAL INSTALLATION**  
**CENTRE DISTANCE 57 mm**

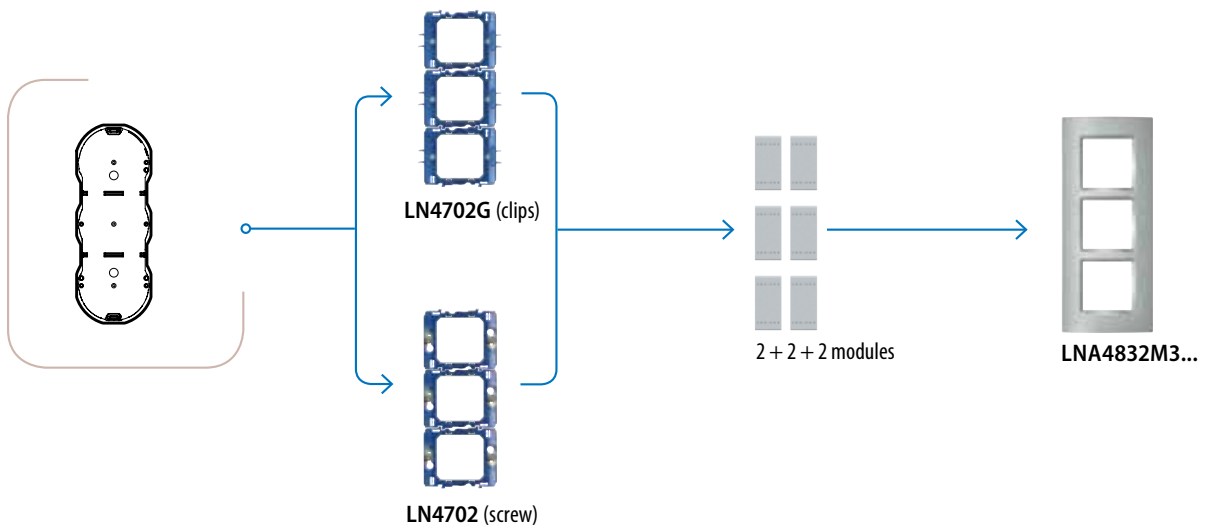
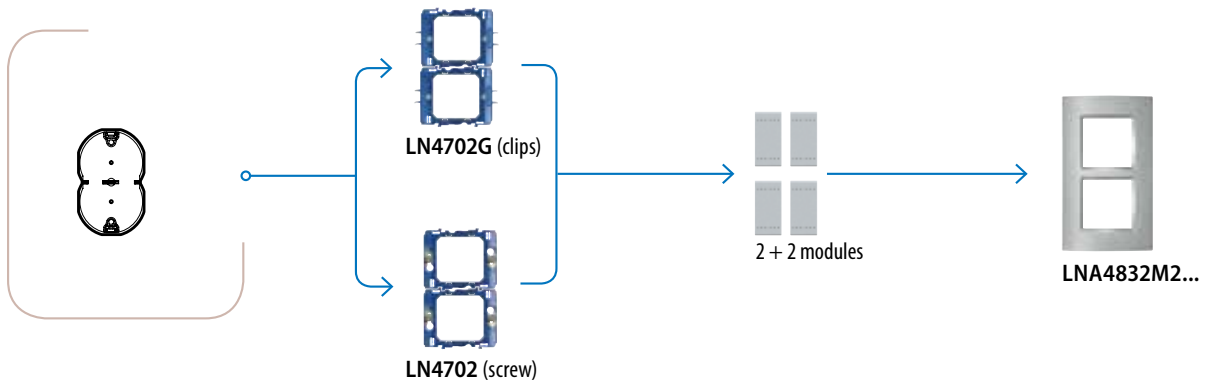

## INSTALLATION OF LN4702 AND LN4702G SUPPORTS

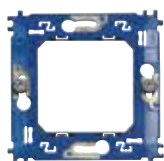

LN4702 (fixing with screw)

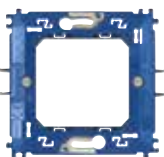

LN4702G (fixing with clips)

### 71 mm centre distance installation

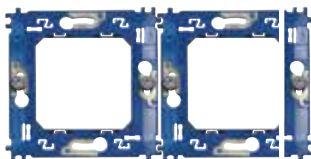

To place side by side 2 or more supports

### 57 mm centre distance installation

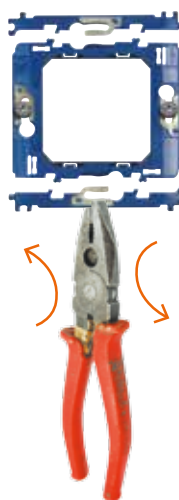



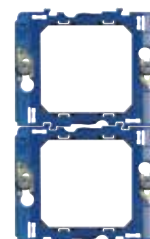







Before placing side by side 2 or more supports, detach upper and lower sides as indicated













# LIVINGLIGHT - 2 MODULE AREA INSTALLATION SYSTEM

## Square cover plate colours

<b>METALS</b> Material: zamak			
	<b>Ice gold - OA</b>	<b>Bronze - BZ</b>	<b>Nickel - NS</b>
<b>NATURALIA</b> Material: zamak			
	<b>Native - NA</b>	<b>Silver - AG</b>	<b>Brushed steel - ACS</b>
<b>SILK</b> Material: zamak			
	<b>Park - PK</b>	<b>Square - SQ</b>	<b>Brick - RK</b>
			
	<b>Avenue - AE</b>	<b>Club - CB</b>	

**SQUARE COVER PLATE CODES**























- 2 modules - LNA4802...
- 2+2 modules - centre distance 71 mm - LNA4802M2...
- 2+2+2 modules - centre distance 71 mm - LNA4802M3...
- 2+2+2+2 modules - centre distance 71 mm - LNA4802M4...
- 2+2 modules - centre distance 57 mm - LNA4832M2...
- 2+2+2 modules - centre distance 57 mm LNA4832M3...

<p><b>DEEP</b> Material: polymer plastic</p>			
<p><b>KRISTALL</b> Material: polymer plastic</p>			
<p><b>NEUTRAL</b> Material: polymer plastic</p>			
<p><b>ESSENCES</b> Material: solid wood</p>			



# LIVINGLIGHT - 2 MODULE AREA INSTALLATION SYSTEM

## Square cover plates: table for selecting codes

		MODULES					
		2	2+2 Centre distance 71 mm	2+2+2 Centre distance 71 mm	2+2+2+2 Centre distance 71 mm	2+2 Centre distance 57 mm	2+2+2 Centre distance 57 mm
<b>METALS (zamak)</b>							
	Ice gold	LNA4802OA	LNA4802M2OA	LNA4802M3OA	LNA4802M4OA	LNA4832M2OA	LNA4832M3OA
	Bronze	LNA4802BZ	LNA4802M2BZ	LNA4802M3BZ	LNA4802M4BZ	LNA4832M2BZ	LNA4832M3BZ
	Nickel	LNA4802NS	LNA4802M2NS	LNA4802M3NS	LNA4802M4NS	LNA4832M2NS	LNA4832M3NS
<b>NATURALIA (zamak)</b>							
	Native	LNA4802NA	LNA4802M2NA	LNA4802M3NA	LNA4802M4NA	LNA4832M2NA	LNA4832M3NA
	Silver	LNA4802AG	LNA4802M2AG	LNA4802M3AG	LNA4802M4AG	LNA4832M2AG	LNA4832M3AG
	Brushed steel	LNA4802ACS	LNA4802M2ACS	LNA4802M3ACS	LNA4802M4ACS	LNA4832M2ACS	LNA4832M3ACS
<b>SILK (zamak)</b>							
	Park	LNA4802PK	LNA4802M2PK	LNA4802M3PK	LNA4802M4PK	LNA4832M2PK	LNA4832M3PK
	Square	LNA4802SQ	LNA4802M2SQ	LNA4802M3SQ	LNA4802M4SQ	LNA4832M2SQ	LNA4832M3SQ
	Brick	LNA4802RK	LNA4802M2RK	LNA4802M3RK	LNA4802M4RK	LNA4832M2RK	LNA4832M3RK
	Avenue	LNA4802AE	LNA4802M2AE	LNA4802M3AE	LNA4802M4AE	LNA4832M2AE	LNA4832M3AE
	Club	LNA4802CB	LNA4802M2CB	LNA4802M3CB	LNA4802M4CB	LNA4832M2CB	LNA4832M3CB
<b>DEEP (polymer plastic)</b>							
	Green	LNA4802VD	LNA4802M2VD	LNA4802M3VD	LNA4802M4VD	LNA4832M2VD	LNA4832M3VD
	Orange	LNA4802OD	LNA4802M2OD	LNA4802M3OD	LNA4802M4OD	LNA4832M2OD	LNA4832M3OD
	Blue	LNA4802AD	LNA4802M2AD	LNA4802M3AD	LNA4802M4AD	LNA4832M2AD	LNA4832M3AD
<b>KRISTALL (polymer plastic)</b>							
	London fog	LNA4802KF	LNA4802M2KF	LNA4802M3KF	LNA4802M4KF	LNA4832M2KF	LNA4832M3KF
	Aquamarine	LNA4802KA	LNA4802M2KA	LNA4802M3KA	LNA4802M4KA	LNA4832M2KA	LNA4832M3KA
	Cold grey	LNA4802KG	LNA4802M2KG	LNA4802M3KG	LNA4802M4KG	LNA4832M2KG	LNA4832M3KG
<b>NEUTRAL (polymer plastic)</b>							
	Anthracite	LNA4802AR	LNA4802M2AR	LNA4802M3AR	LNA4802M4AR	LNA4832M2AR	LNA4832M3AR
	White	LNA4802BI	LNA4802M2BI	LNA4802M3BI	LNA4802M4BI	LNA4832M2BI	LNA4832M3BI
	Tech	LNA4802TE	LNA4802M2TE	LNA4802M3TE	LNA4802M4TE	LNA4832M2TE	LNA4832M3TE
<b>WOOD</b>							
	Cherrywood	LNA4802LCA	LNA4802M2LCA	LNA4802M3LCA	LNA4802M4LCA	LNA4832M2LCA	LNA4832M3LCA
	Bamboo	LNA4802LBA	LNA4802M2LBA	LNA4802M3LBA	LNA4802M4LBA	LNA4832M2LBA	LNA4832M3LBA
	Walnut	LNA4802LNC	LNA4802M2LNC	LNA4802M3LNC	LNA4802M4LNC	LNA4832M2LNC	LNA4832M3LNC
<b>SUPPORTS</b>							
	Fixing with screws	LN4702M	LN4702M (x2)	LN4702M (x3)	LN4702M (x4)	LN4702 (x3)	LN4702 (x3)
	Fixing with clips	LN4702MG	LN4702MG (x2)	LN4702MG (x3)	LN4702MG (x4)	LN4702G (x3)	LN4702G (x3)

# LIVINGLIGHT AIR - 2 MODULE AREA INSTALLATION SYSTEM

## Cover plate installation

Boxes

Supports

No. of modules

Cover plates

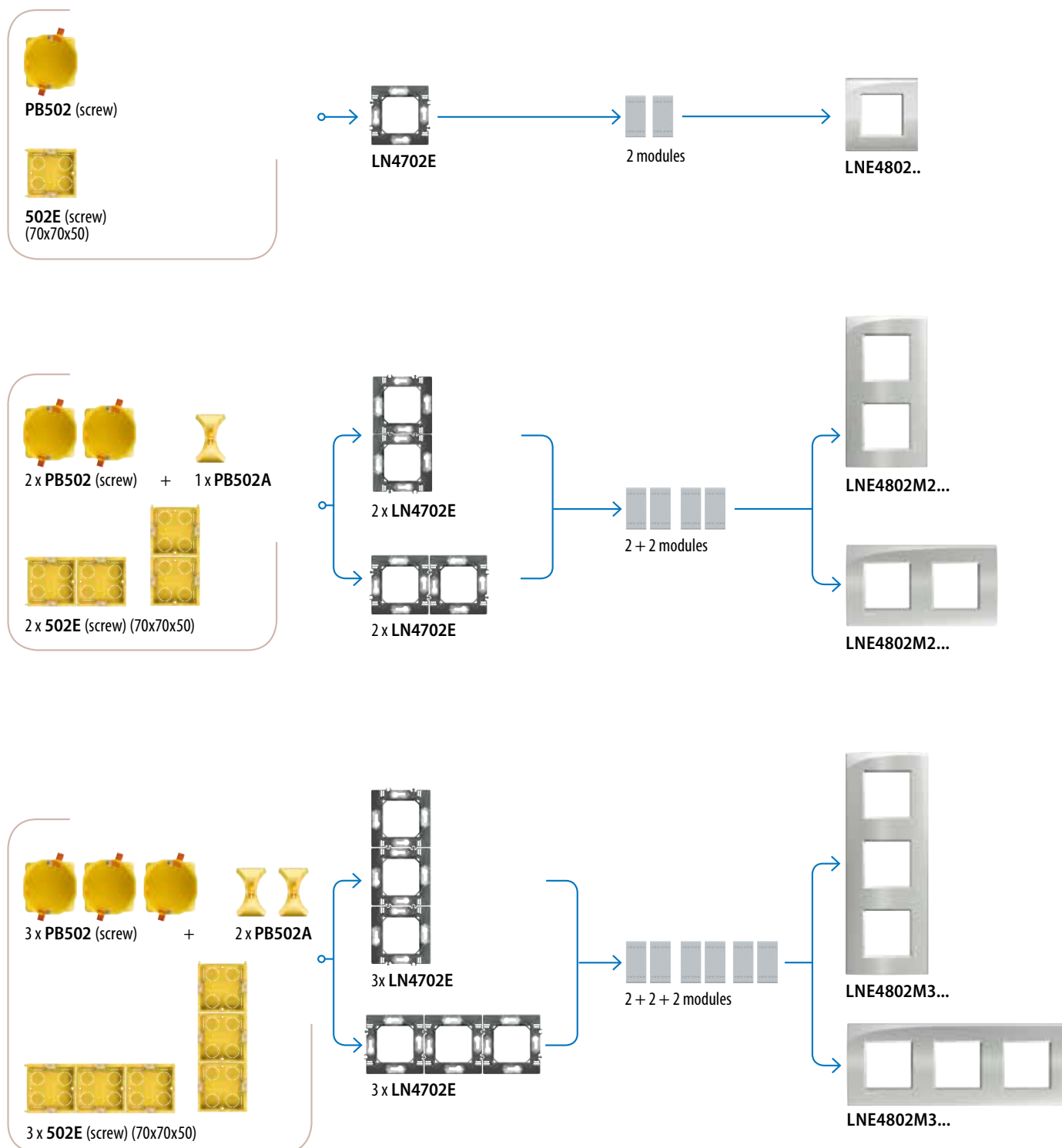

**Note:** 40 mm dept boxes for flexible cables installations  
 50 mm dept boxes for rigid cables installations  
 PB502A = accessory for side by side installation of 502PB boxes













**Note:** The clear protection is supplied **as standard with Air supports**, to preserve the integrity of the devices, protecting them from installation dust, paint and scratches during all stages after their installation, and until the cover plates are fitted.

# LIVINGLIGHT AIR - 2 MODULE AREA INSTALLATION SYSTEM

## Cover plate colours



## Cover plates: table for selecting codes

		<b>MODULES</b>		
		2	2+2	2+2+2
<b>AIR COVER PLATE CODES</b>				
2 modules - LNE4802...				
2+2 modules - LNE4802M2...				
2+2+2 modules - LNE4802M3...				
<b>NEUTRAL (zamak)</b>				
	Pure white	LNE4802BN	LNE4802M2BN	LNE4802M3BN
	Tech	LNE4802TE	LNE4802M2TE	LNE4802M3TE
	Lava	LNE4802NL	LNE4802M2NL	LNE4802M3NL
	Moonlight silver	LNE4802GL	LNE4802M2GL	LNE4802M3GL
	Pearl white	LNE4802PR	LNE4802M2PR	LNE4802M3PR
<b>SHINY (zamak)</b>				
	Palladium	LNE4802PL	LNE4802M2PL	LNE4802M3PL
	Pewter	LNE4802PT	LNE4802M2PT	LNE4802M3PT
	Nickel	LNE4802NK	LNE4802M2NK	LNE4802M3NK
	Gold mat	LNE4802OF	LNE4802M2OF	LNE4802M3OF
<b>DECORATIONS (zamak)</b>				
	Net	LNE4802NE	LNE4802M2NE	LNE4802M3NE
	Ramage	LNE4802RM	LNE4802M2RM	LNE4802M3RM
	Stripes	LNE4802SP	LNE4802M2SP	LNE4802M3SP
	Greek	LNE4802GK	LNE4802M2GK	LNE4802M3GK
<b>SUPPORTS</b>				
Supports		LN4702E	LN4702E x 2	LN4702E x 3

# LIVINGLIGHT AND LIVING INTERNATIONAL 3 MODULE AREA INSTALLATION SYSTEM

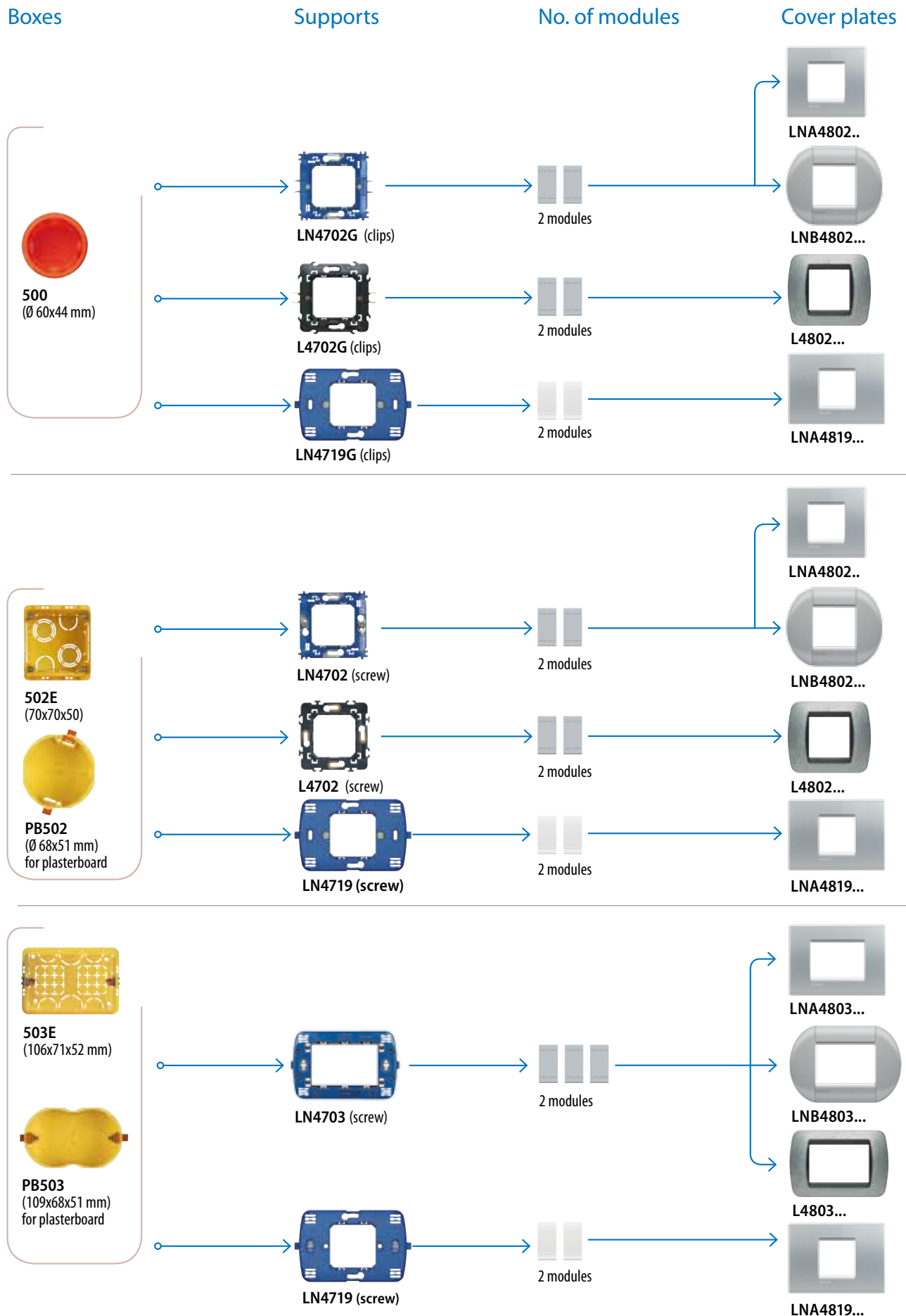

**Boxes**



**504E**  
(133x74x53,5 mm)



**PB504**  
(131,5x68x51 mm)  
for plasterboard

**Supports**



**LN4704** (screw)

**No. of modules**

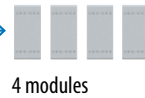

4 modules

**Cover plates**



**LNA4804...**



**LNB4804...**



**L4804...**



**506L**  
(183,5x90x53,5 mm)



**PB506**  
(182x68x51 mm)  
for plasterboard



**LN4707** (screw)



7 modules



**LNA4807...**



**LNB4807...**



**L4807...**

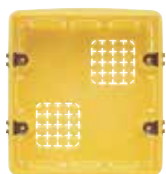

**506E**  
(106x117x52 mm)



**PB526**  
(109x114x51 mm)  
for plasterboard

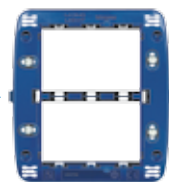

**LN4726** (screw)

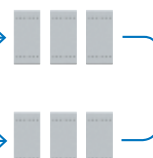

3 + 3 modules



accessories supplied in  
the product colour range



**LNA4826...**













**LNB4826...**

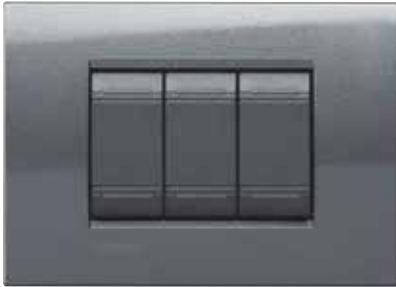



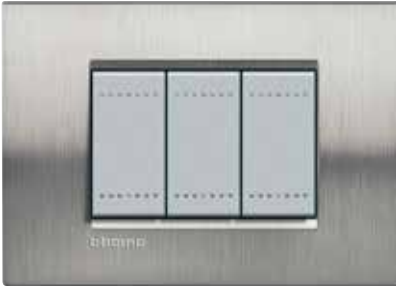



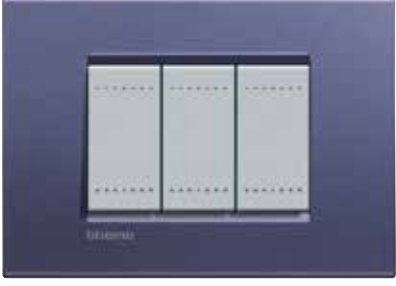





**L4826...**

# LIVINGLIGHT - 3 MODULE AREA INSTALLATION SYSTEM

## Square cover plate colours











<b>METALS</b> Material: zamak	 <p><b>Ice gold - OA</b></p>	 <p><b>Bronze - BZ</b></p>	 <p><b>Nickel - NS</b></p>		
	 <p><b>Steel - AC</b></p>	 <p><b>Moonlight - GL</b></p>			
	<b>NATURALIA</b> Material: zamak	 <p><b>Native - NA</b></p>	 <p><b>Silver - AG</b></p>	 <p><b>Brushed steel - ACS</b></p>	
		<b>SILK</b> Material: zamak	 <p><b>Park - PK</b></p>	 <p><b>Square - SQ</b></p>	 <p><b>Brick - RK</b></p>
			 <p><b>Avenue - AE</b></p>	 <p><b>Club - CB</b></p>	<p><b>SQUARE COVER PLATE CODES</b></p> <ul style="list-style-type: none"> <li>2 modules - LNA4802...</li> <li>2 central modules - LNA4819...</li> <li>3 modules - LNA4803...</li> <li>4 modules - LNA4804...</li> <li>7 modules - LNA4807...</li> <li>3+3 modules - LNA4826...</li> </ul>

<p><b>DEEP</b> Material: polymer plastic</p>	 <p><b>Green - VD</b></p>	 <p><b>Orange - OD</b></p>	 <p><b>Blue - AD</b></p>
<p><b>KRISTALL</b> Material: polymer plastic</p>	 <p><b>London fog - KF</b></p>	 <p><b>Acquamarine - KA</b></p>	 <p><b>Cold grey - KG</b></p>
<p><b>NEUTRAL</b> Material: polymer plastic</p>	 <p><b>Anthracite - AR</b></p>	 <p><b>White - BI</b></p>	 <p><b>Tech - TE</b></p>
<p><b>ESSENCES</b> Material: solid wood</p>	 <p><b>Cherrywood - LCA</b></p>	 <p><b>Bamboo - LBA</b></p>	 <p><b>Walnut - LNC</b></p>



# LIVINGLIGHT - 3 MODULE AREA INSTALLATION SYSTEM

## Round cover plate colours

























<b>METALS</b> Material: zamak			
	<p><b>Gold - OC</b></p>	<p><b>Dark steel - AC</b></p>	<p><b>Titanium - TC</b></p>
			
	<p><b>Chrome - CR</b></p>		
<b>NATURALIA</b> Material: zamak			
	<p><b>Graphite - GF</b></p>	<p><b>Marrakech - MA</b></p>	<p><b>Cordoba - CO</b></p>
		<p><b>ROUND COVER PLATE CODES</b>                      2 modules - LNB4802...                      3 modules - LNB4803...                      4 modules - LNB4804...                      7 modules - LNB4807...                      3+3 modules - LNB4826...</p>	
	<p><b>Siena - SI</b></p>		
<b>GLOSSY</b> Material: zamak			
	<p><b>Grape - GP</b></p>	<p><b>Citron - CT</b></p>	<p><b>Sunset - SS</b></p>



On request of the customer, LIVINGLIGHT cover plates may be supplied with customised graphics. Each mark may consist of one or two colours. The requests, minimum quantity 20 pieces, must be forwarded through the electric material distributor.

# LIVINGLIGHT - 3 MODULE AREA INSTALLATION SYSTEM

## Square cover plates: table for selecting codes

		MODULES					
		2	2 centred	3	4	7	3+3
<b>METALS (zamak)</b>							
	Ice gold	LNA4802OA	LNA4819OA	LNA4803OA	LNA4804OA	LNA4807OA	LNA4826OA
	Bronze	LNA4802BZ	LNA4819BZ	LNA4803BZ	LNA4804BZ	LNA4807BZ	LNA4826BZ
	Nickel	LNA4802NS	LNA4819NS	LNA4803NS	LNA4804NS	LNA4807NS	LNA4826NS
	Steel	LNA4802AC	LNA4819AC	LNA4803AC	LNA4804AC	LNA4807AC	LNA4826AC
	Moolight silver	LNA4802GL	LNA4819GL	LNA4803GL	LNA4804GL	LNA4807GL	LNA4826GL
<b>NATURALIA (zamak)</b>							
	Native	LNA4802NA	LNA4819NA	LNA4803NA	LNA4804NA	LNA4807NA	LNA4826NA
	Silver	LNA4802AG	LNA4819AG	LNA4803AG	LNA4804AG	LNA4807AG	LNA4826AG
	Brushed steel	LNA4802ACS	LNA4819ACS	LNA4803ACS	LNA4804ACS	LNA4807ACS	LNA4826ACS
<b>SILK (zamak)</b>							
	Park	LNA4802PK	LNA4819PK	LNA4803PK	LNA4804PK	LNA4807PK	LNA4826PK
	Square	LNA4802SQ	LNA4819SQ	LNA4803SQ	LNA4804SQ	LNA4807SQ	LNA4826SQ
	Brick	LNA4802RK	LNA4819RK	LNA4803RK	LNA4804RK	LNA4807RK	LNA4826RK
	Avenue	LNA4802AE	LNA4819AE	LNA4803AE	LNA4804AE	LNA4807AE	LNA4826AE
	Club	LNA4802CB	LNA4819CB	LNA4803CB	LNA4804CB	LNA4807CB	LNA4826CB
<b>DEEP (polymer plastic)</b>							
	Green	LNA4802VD	LNA4819VD	LNA4803VD	LNA4804VD	LNA4807VD	LNA4826VD
	Orange	LNA4802OD	LNA4819OD	LNA4803OD	LNA4804OD	LNA4807OD	LNA4826OD
	Blue	LNA4802AD	LNA4819AD	LNA4803AD	LNA4804AD	LNA4807AD	LNA4826AD
<b>KRISTALL (polymer plastic)</b>							
	London fog	LNA4802KF	LNA4819KF	LNA4803KF	LNA4804KF	LNA4807KF	LNA4826KF
	Aquamarine	LNA4802KA	LNA4819KA	LNA4803KA	LNA4804KA	LNA4807KA	LNA4826KA
	Cold grey	LNA4802KG	LNA4819KG	LNA4803KG	LNA4804KG	LNA4807KG	LNA4826KG
<b>NEUTRAL (polymer plastic)</b>							
	Anthracite	LNA4802AR	LNA4819AR	LNA4803AR	LNA4804AR	LNA4807AR	LNA4826AR
	White	LNA4802BI	LNA4819BI	LNA4803BI	LNA4804BI	LNA4807BI	LNA4826BI
	Tech	LNA4802TE	LNA4819TE	LNA4803TE	LNA4804TE	LNA4807TE	LNA4826TE
<b>WOOD</b>							
	Cherrywood	LNA4802LCA	LNA4819LCA	LNA4803LCA	LNA4804LCA	LNA4807LCA	LNA4826LCA
	Bamboo	LNA4802LBA	LNA4819LBA	LNA4803LBA	LNA4804LBA	LNA4807LBA	LNA4826LBA
	Walnut	LNA4802LNC	LNA4819LNC	LNA4803LNC	LNA4804LNC	LNA4807LNC	LNA4826LNC
<b>SUPPORTS</b>							
	Fixing with screws	LN4702	LN4719	LN4703	LN4704	LN4707	LN4726
	Fixing with clips	LN4702G	LN4719G				

## Round cover plates: table for selecting codes

### MODULES

		2	3	4	7	3+3
<b>METALS (zamak)</b>						
	Gold	LNB4802OC	LNB4803OC	LNB4804OC	LNB4807OC	LNB4826OC
	Dark steel	LNB4802AC	LNB4803AC	LNB4804AC	LNB4807AC	LNB4826AC
	Titanium	LNB4802TC	LNB4803TC	LNB4804TC	LNB4807TC	LNB4826TC
	Chrome	LNB4802CR	LNB4803CR	LNB4804CR	LNB4807CR	LNB4826CR
<b>NATURALIA (zamak)</b>						
	Graphite	LNB4802GF	LNB4803GF	LNB4804GF	LNB4807GF	LNB4826GF
	Marrakech	LNB4802MA	LNB4803MA	LNB4804MA	LNB4807MA	LNB4826MA
	Cordoba	LNB4802CO	LNB4803CO	LNB4804CO	LNB4807CO	LNB4826CO
	Siena	LNB4802SI	LNB4803SI	LNB4804SI	LNB4807SI	LNB4826SI
<b>GLOSSY (zamak)</b>						
	Grape	LNB4802GP	LNB4803GP	LNB4804GP	LNB4807GP	LNB4826GP
	Citron	LNB4802CT	LNB4803CT	LNB4804CT	LNB4807CT	LNB4826CT
	Sunset	LNB4802SS	LNB4803SS	LNB4804SS	LNB4807SS	LNB4826SS
<b>TWIN (polymer plastic)</b>						
	Brown	LNB4802TW	LNB4803TW	LNB4804TW	LNB4807TW	LNB4826TW
	Sky	LNB4802TS	LNB4803TS	LNB4804TS	LNB4807TS	LNB4826TS
	Bronze	LNB4802TB	LNB4803TB	LNB4804TB	LNB4807TB	LNB4826TB
<b>CLASSY (polymer plastic)</b>						
	Smoking	LNB4802SM	LNB4803SM	LNB4804SM	LNB4807SM	LNB4826SM
	Colonial	LNB4802CL	LNB4803CL	LNB4804CL	LNB4807CL	LNB4826CL
	Tight	LNB4802TG	LNB4803TG	LNB4804TG	LNB4807TG	LNB4826TG
<b>NEUTRAL (polymer plastic)</b>						
	Anthracite	LNB4802AR	LNB4803AR	LNB4804AR	LNB4807AR	LNB4826AR
	White	LNB4802BI	LNB4803BI	LNB4804BI	LNB4807BI	LNB4826BI
	Tech	LNB4802TE	LNB4803TE	LNB4804TE	LNB4807TE	LNB4826TE
<b>WOOD</b>						
	Cherrywood	LNB4802LCA	LNB4803LCA	LNB4804LCA	LNB4807LCA	LNB4826LCA
	Maple	LNB4802LAE	LNB4803LAE	LNB4804LAE	LNB4807LAE	LNB4826LAE
	Oak	LNB4802LRW	LNB4803LRW	LNB4804LRW	LNB4807LRW	LNB4826LRW

### SUPPORTS

Fixing with screws	LN4702	LN4703	LN4704	LN4707	LN4726
Fixing with clips	LN4702G				

# LIVING INTERNATIONAL - 3 MODULE AREA INSTALLATION SYSTEM

## Cover plate colours

<b>METALLIC</b>			
	<b>Light aluminium - AL</b>	<b>Dark steel - AC</b>	<b>Light titanium - TC</b>
			
	<b>Oxidized bronze - BO</b>	<b>Solid black - NR</b>	
<b>SHINY</b>			
	<b>Bright chrome - CR</b>	<b>True gold - OR</b>	
<b>SPECIAL</b>			
	<b>Brushed steel - ACS</b>	<b>Graphite - GF</b>	<b>Black graphite - GFN</b>
			
			<b>Bakelite - BK</b>

**LIVINGLIGHT ROUND COVER PLATES CODES**  
2 modules - L4802...  
3 modules - L4803...  
4 modules - L4804...  
7 modules - L4807...  
3+3 modules - L4826...

\* (not available in the modularity 3+3)



\* (not available in the modularity 3+3)

NOTE for new plates: White plate with white inner frame, plates Tech, Chrome and Brushed steel with Tech inner frame

## LIVING INTERNATIONAL: table for selecting codes

	MODULES					
	2	3	4	7	3+3	
<b>METALLIC</b>						
	Light aluminium	L4802AL	L4803AL	L4804AL	L48027L	L4826AL
	Dark steel	L4802AC	L4803AC	L4804AC	L48027C	L4826AC
	Light titanium	L4802TC	L4803TC	L4804TC	L4807TC	L4826TC
	Oxidized bronze	L4802BO	L4803BO	L4804BO	L4807BO	L4826BO
	Solid black	L4802NR	L4803NR	L4804NR	L4807NR	L4826NR
<b>SHINY</b>						
	Bright chrome	L4802CR	L4803CR	L4804CR	L4807CR	L4826CR
	True gold	L4802OR	L4803OR	L4804OR	L4807OR	L4826OR
<b>SPECIAL</b>						
	Brushed steel	L4802ACS	L4803ACS	L4804ACS	L4807ACS	L4826ACS
	Graphite	L4802GF	L4803GF	L4804GF	L4807GF	L4826GF
	Black graphite	L4802GFN	L4803GFN	L4804GFN	L4807GFN	L4826GFN
	Bakelite	L4802BK	L4803BK	L4804BK	L4807BK	
<b>TECH</b>						
	Tech	L4802TE	L4803TE	L4804TE	L4807TE	L4826TE
	Chrome	L4802CT	L4803CT	L4804CT	L4807CT	L4826CT
	Brushed steel	L4802AST	L4803AST	L4804AST	L4807AST	L4826AST
<b>POLYMER</b>						
	Dark steel	L4802PA	L4803PA	L4804PA	L4807PA	
	White	L4802PB	L4803PB	L4804PB	L4807PB	
	All White	L4802BI	L4803BI	L4804BI	L4807BI	
<b>SUPPORTS</b>						
	Supports	L4702-L4702G	LN4703	LN4704	LN4707	LN4726

# LIVINGLIGHT AIR - 3 MODULE AREA INSTALLATION SYSTEM

## Cover plate installation

### Boxes

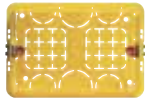

**503E**  
(106x71x52 mm)



**PB503**  
(109x68x51 mm)  
for plasterboard

### Supports



**LN4703C** with screws

### No. of modules



3 modules

### AIR cover plates



**LNC4803...**

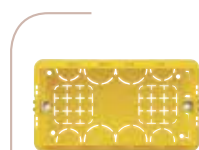

**504E**  
(133x74x53.5 mm)



**PB504**  
(131.5x68x51 mm)  
for plasterboard



**LN4704C** with screws



4 modules



**LNC4804...**



**Note:** The clear protection is supplied as standard with Air supports, to preserve the integrity of the devices, protecting them from installation dust, paint and scratches during all stages after their installation, and until the cover plates are fitted.

**Boxes**

**Supports**

**No. of modules**



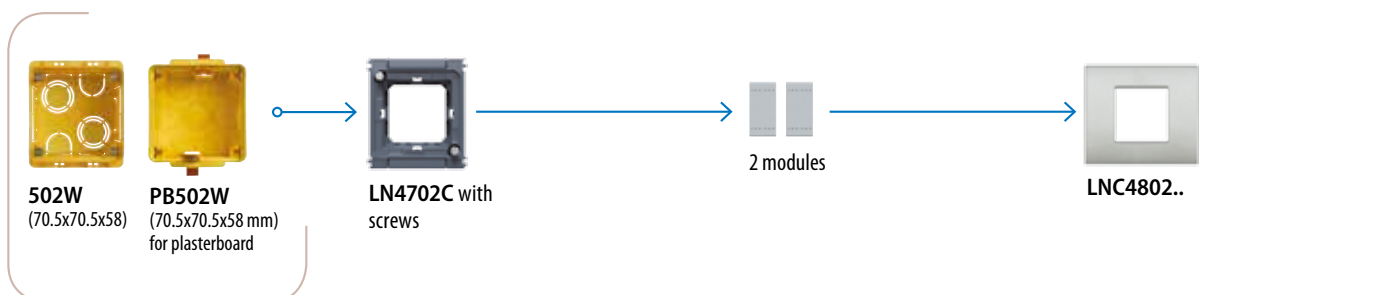
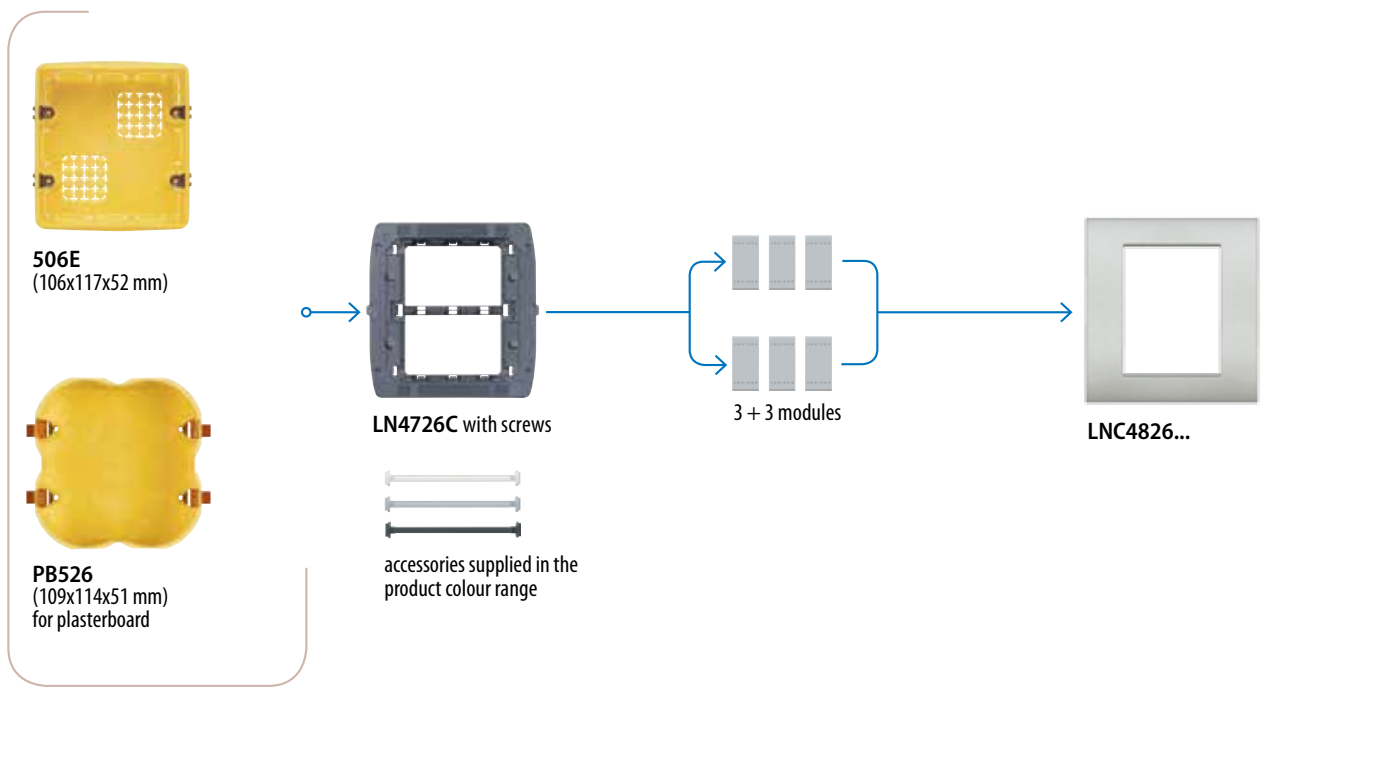
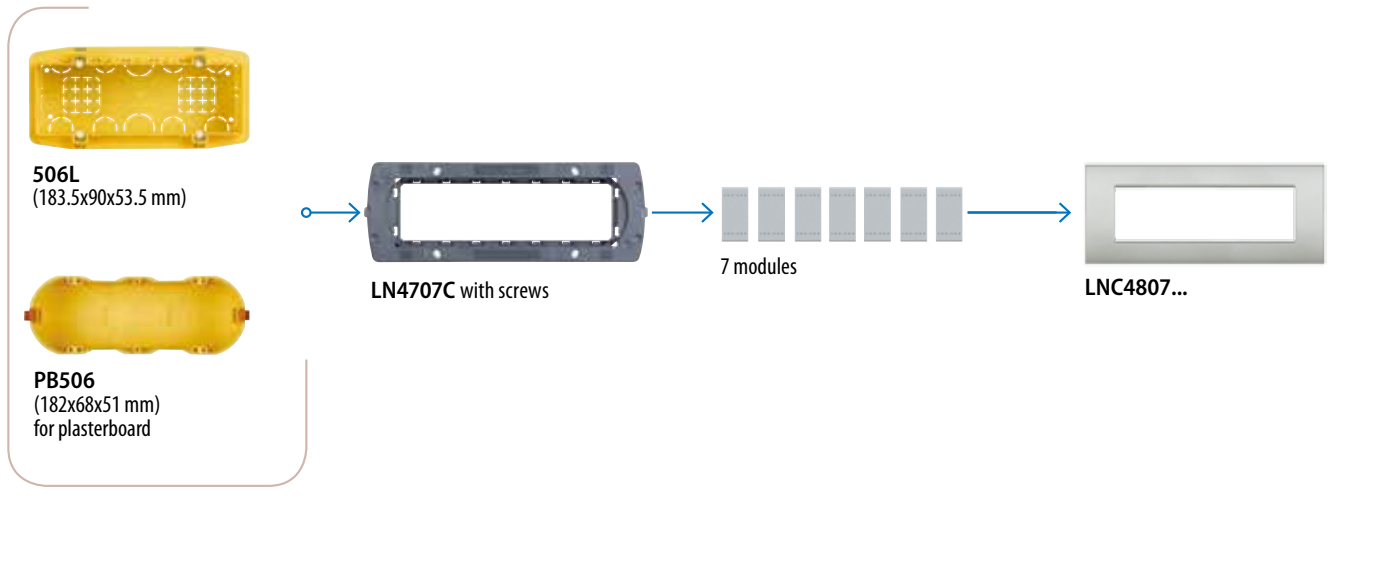







**AIR cover plates**



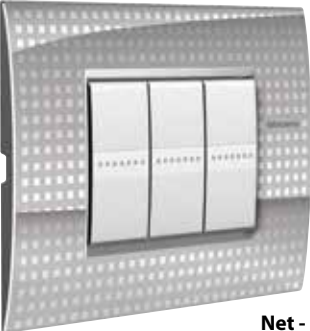

# LIVINGLIGHT AIR - 3 MODULE AREA INSTALLATION SYSTEM

## Cover plate colours

<b>MONOCHROME</b> Material: zamak	 <p>Pure white - BN</p>	 <p>Tech - TE</p>	 <p>Anthracite - AR</p>
	 <p>Pewter - PT</p>	 <p>Palladium - PL</p>	 <p>Gold mat - OF</p>
	 <p>Nickel mat - NK</p>		
<b>SHINY</b> Material: zamak	 <p>Ramage - RM</p>	 <p>Greek - GK</p>	 <p>Net - NE</p>
	 <p>Stripes - SP</p>		
	<p><b>AIR COVER PLATE CODES</b>                      2 modules - LNC4802...                      3 modules - LNC4803...                      4 modules - LNC4804...                      7 modules - LNC4807...                      3+3 modules - LNC4826...</p>		





## Cover plates: table for selecting codes

		MODULES				
		2	3	4	7	3+3
<b>MONOCHROME (zamak)</b>						
	Pure white	LNC4802BN	LNC4803BN	LNC4804BN	LNC4807BN	LNC4826BN
	Tech	LNC4802TE	LNC4803TE	LNC4804TE	LNC4807TE	LNC4826TE
	Anthracite	LNC4802AR	LNC4803AR	LNC4804AR	LNC4807AR	LNC4826AR
<b>NEUTRAL (zamak)</b>						
	Lava	LNC4802NL	LNC4803NL	LNC4804NL	LNC4807NL	LNC4826NL
	Pearl white	LNC4802PR	LNC4803PR	LNC4804PR	LNC4807PR	LNC4826PR
	Moonlight silver	LNC4802GL	LNC4803GL	LNC4804GL	LNC4807GL	LNC4826GL
<b>SHINY (zamak)</b>						
	Pewter	LNC4802PT	LNC4803PT	LNC4804PT	LNC4807PT	LNC4826PT
	Palladium	LNC4802PL	LNC4803PL	LNC4804PL	LNC4807PL	LNC4826PL
	Gold mat	LNC4802OF	LNC4803OF	LNC4804OF	LNC4807OF	LNC4826OF
	Nickel mat	LNC4802NK	LNC4803NK	LNC4804NK	LNC4807NK	LNC4826NK
<b>DECORATIONS (zamak)</b>						
	Ramage	LNC4802RM	LNC4803RM	LNC4804RM	LNC4807RM	LNC4826RM
	Greek	LNC4802GK	LNC4803GK	LNC4804GK	LNC4807GK	LNC4826GK
	Net	LNC4802NE	LNC4803NE	LNC4804NE	LNC4807NE	LNC4826NE
	Stripes	LNC4802SP	LNC4803SP	LNC4804SP	LNC4807SP	LNC4826SP
		<b>SUPPORTS</b>				
Supports		LN4702C	LN4703C	LN4704C	LN4707C	LN4726C







# CUSTOMISABLE SWITCHES

When created using tilting control devices, the light point may be customised using transparent key covers and a transparent cover plate. The cover plate, available in 3, 4, 7, and 3+3 module versions, has a removable under plate that can be removed and interleaved with wallpaper, so that it will not stand out from the wall, or using a favourite pattern or photo, to achieve the opposite effect. The same can be done with the 1, 2 or 3 module key covers.



## ITEMS FOR THE CUSTOMISATION OF THE LIGHT POINT

Item	Customisable transparent key cover for rocker control devices	
○ N4932		1 module
○ N4932/2		2 modules
○ N4932/3		3 modules

## Customisable transparent cover plates

○ LND4802KR		2 modules
○ LND4819KR		2 centred modules (LN4719 or LN4719G)
○ LND4803KR		3 modules
○ LND4804KR		4 modules
○ LND4807KR		7 modules
○ LND4826KR		3 + 3 modules

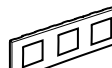

○ LND4802M2KR		2 + 2 modules centre distance 71mm
○ LND4802M3KR		2 + 2 + 2 modules centre distance 71mm
○ LND4832M2KR		2 + 2 modules centre distance 57mm
○ LND4832M3KR		2 + 2 + 2 modules centre distance 57 mm

## COVER PLATE CUSTOMISATION

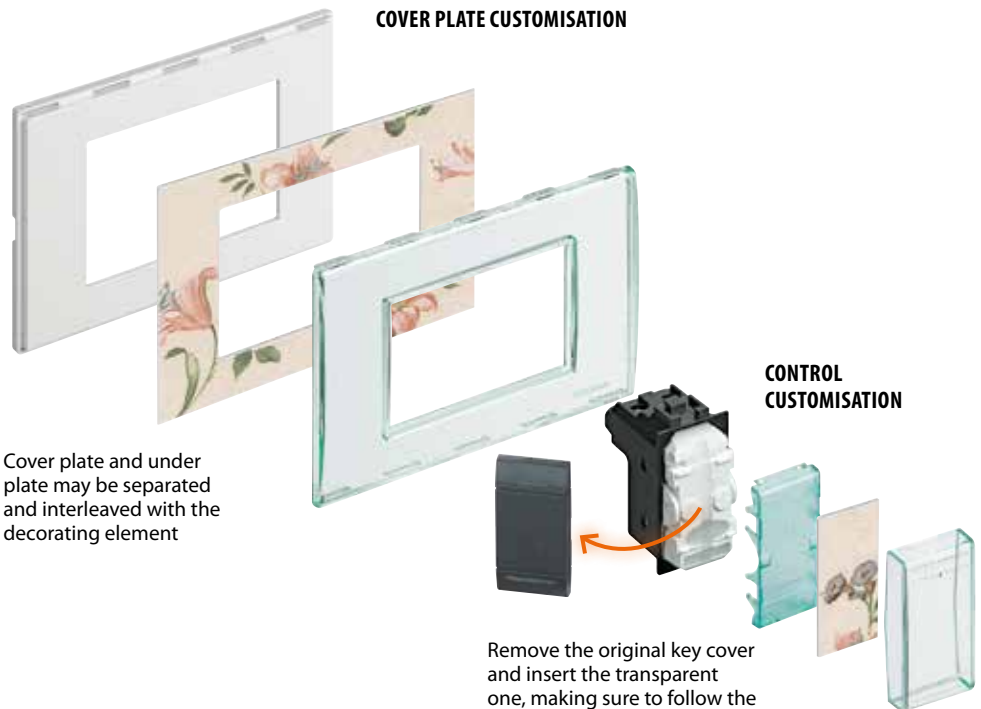

Cover plate and under plate may be separated and interleaved with the decorating element

## CONTROL CUSTOMISATION

Remove the original key cover and insert the transparent one, making sure to follow the assembly sequence.

# WALL MOUNTED INSTALLATION

Boxes	Modules	Cover plates
	 2 modules	   LNB4802... LNA4802... LNE4802...
	 3 modules	   LNB4803... LNA4803... LNC4803...
	 4 modules	   LNB4804... LNA4804... LNC4804...
 502LP with support (93x80x38)	 2 modules	 L4802...
 503LP with support (120x80x38)	 3 modules	 L4803...
 504LP with support (140x80x38)	 4 modules	 L4804...
 N4714 with support and cover plate (215x215x60) (white)	 2 x 7 modules	
 L4714 - with support and cover plate (215x215x60) (anthracite)		
 150418BA with support and cover plate (173x247x65) (white)	 3 x 6 modules	
 150418GR - with support and cover plate (173x247x65) (anthracite)		
 506NP (118x118x55) (white)	 506NP (118x118x55) (white)	 506LP (118x118x55) (anthracite)
 N4070 indoor siren N4565 loudspeaker (white)	 NT4070 indoor siren NT4565 loudspeaker (tech)	 4070 indoor siren L4565 loudspeaker (anthracite)

# INSTALLATION IN PROTECTED HOUSINGS AND OTHER

## INSTALLATION ON PLASTERBOARD, MASONRY WALL AND PROFILES

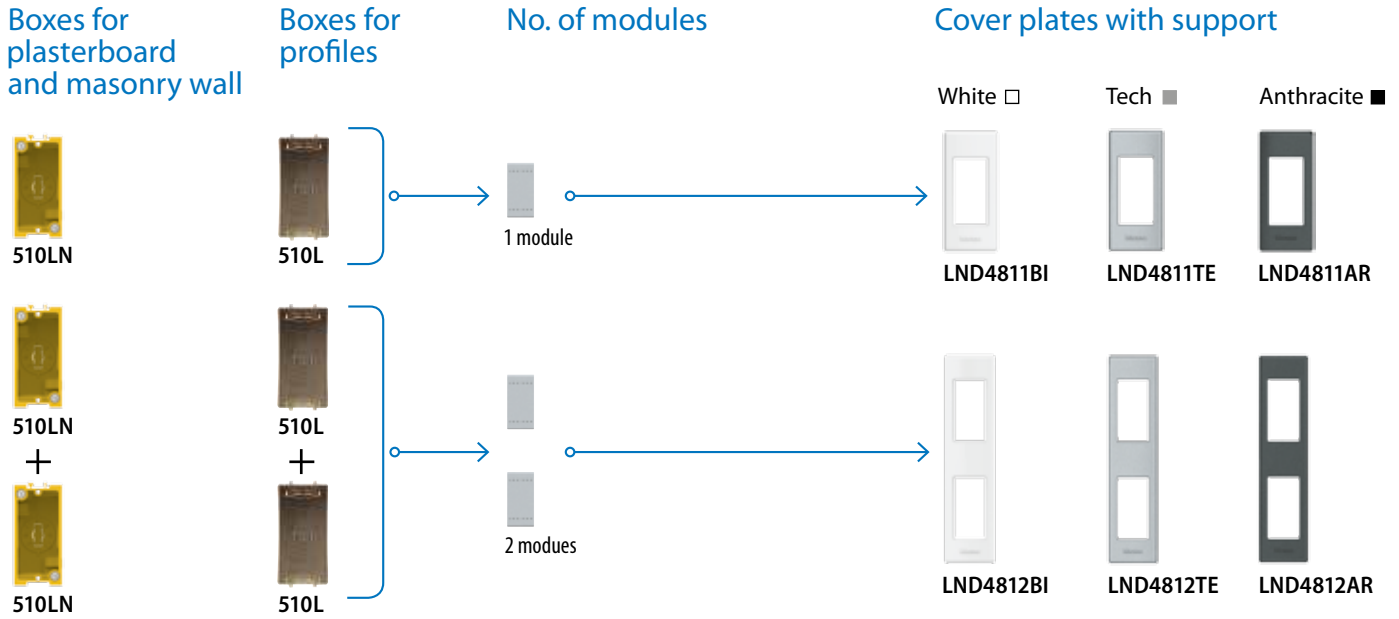

## INSTALLATION IN MULTIBOX BOXES

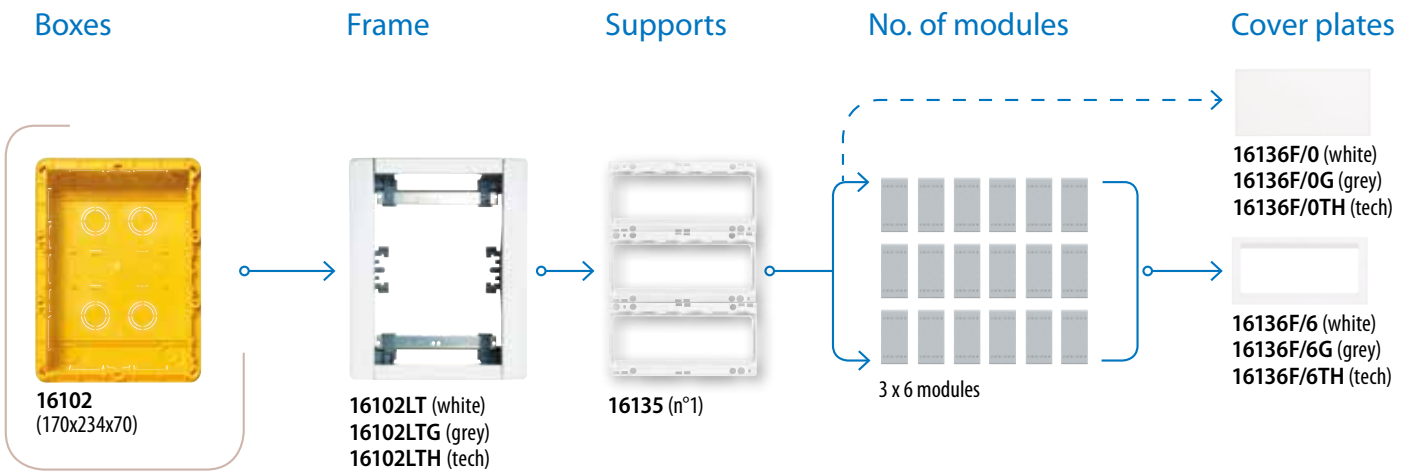

## TABLE MOUNTED INSTALLATION

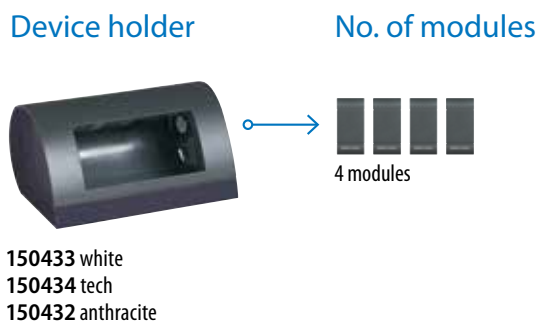

## POP-UP BOXES

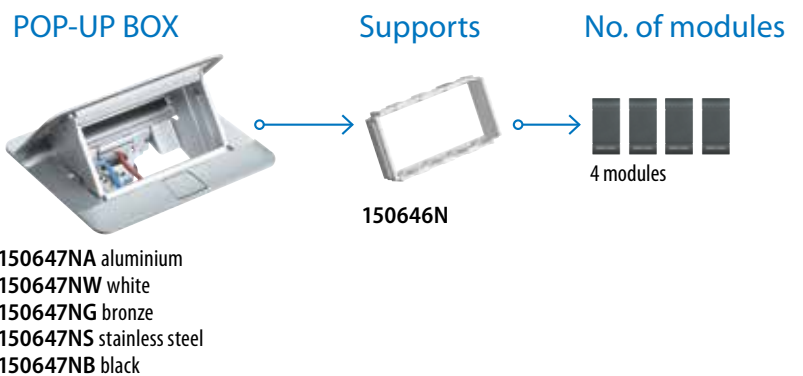

# INSTALLATION IN FLUSH MOUNTED BOXES WITH SELF-SUPPORTING PROTECTED COVERS

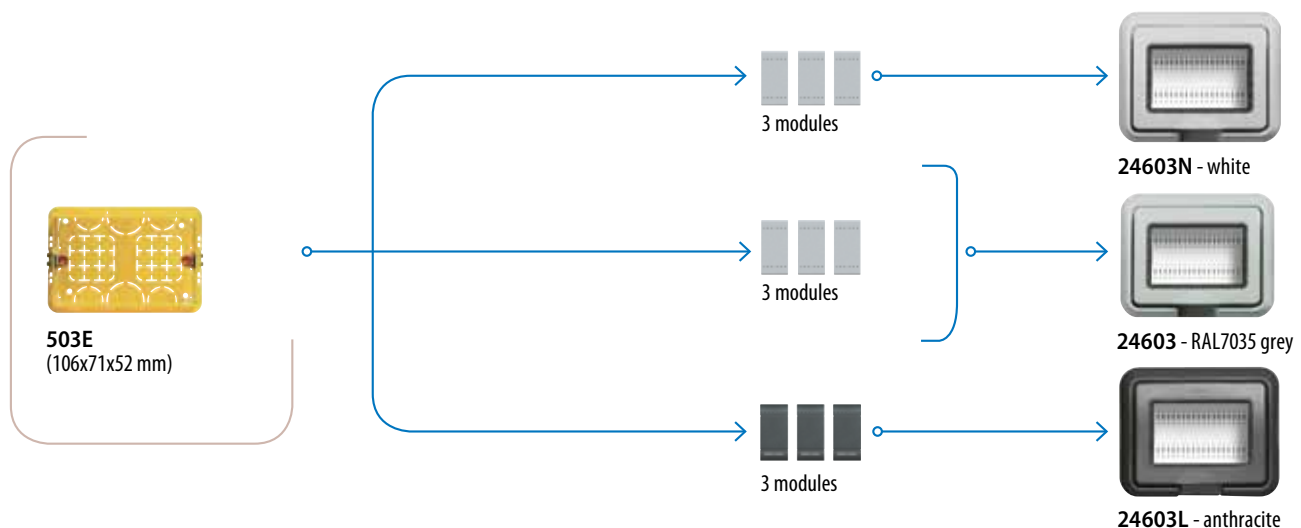
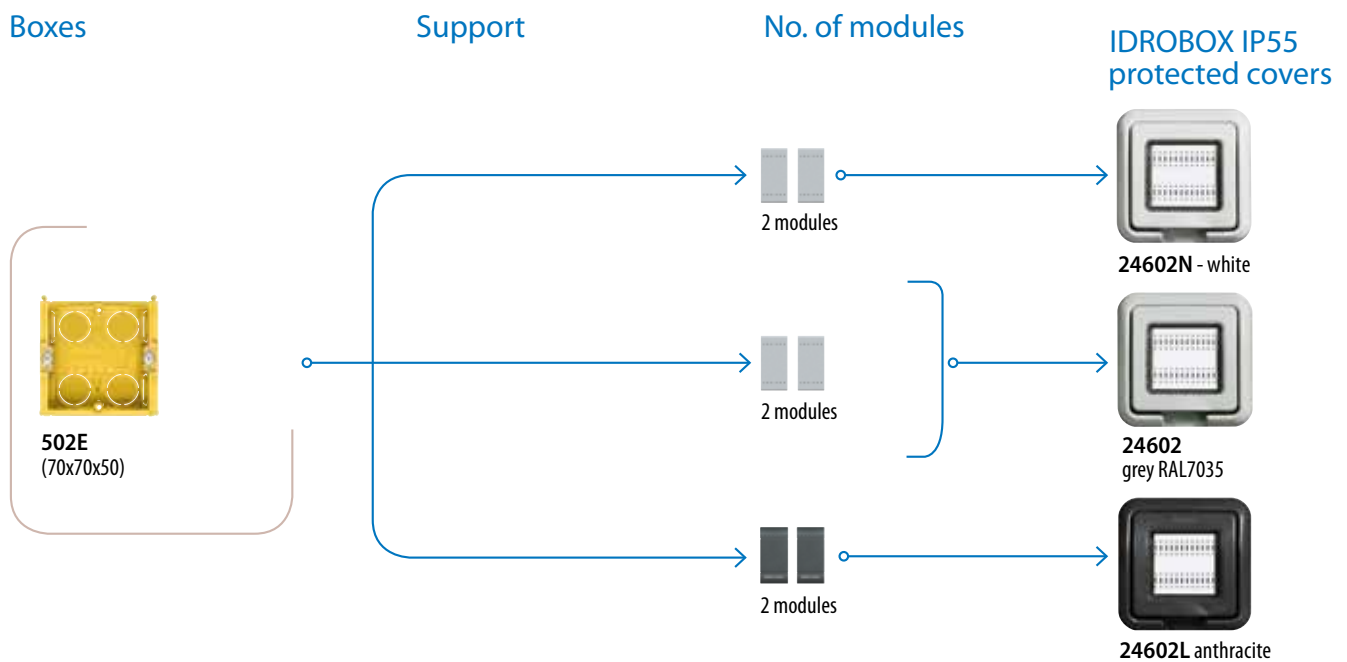
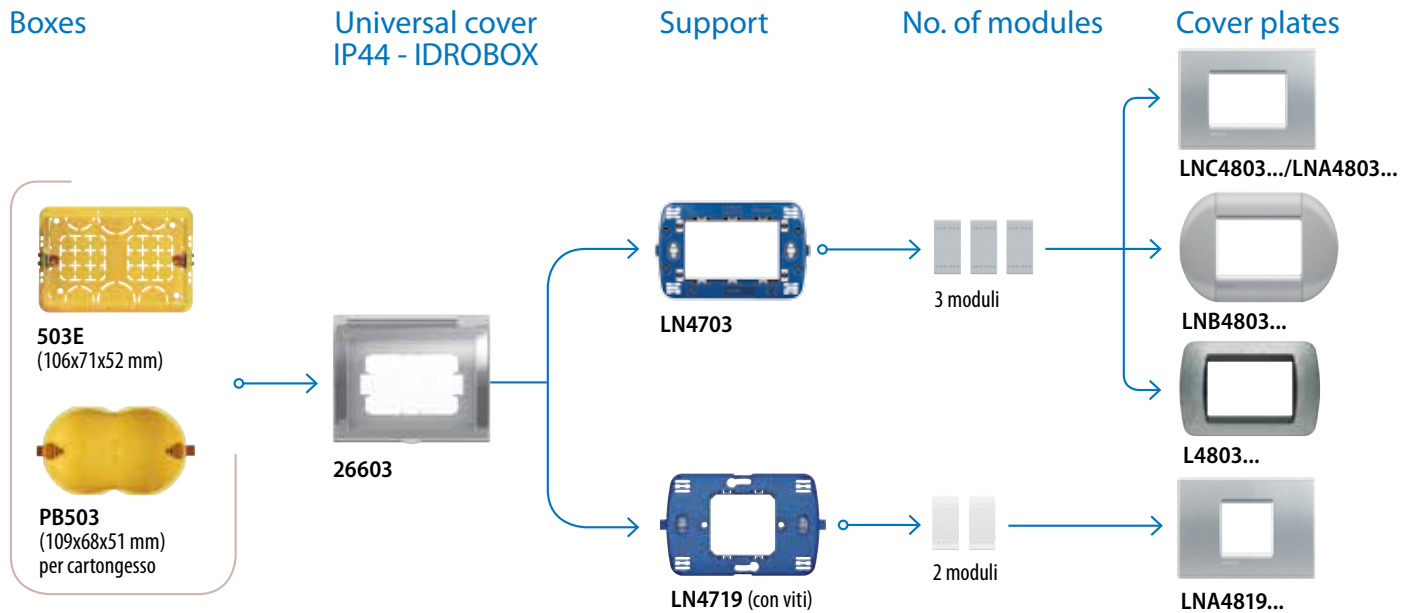

# INSTALLATION IN FLUSH MOUNTED BOXES WITH SELF-SUPPORTING PROTECTED COVERS

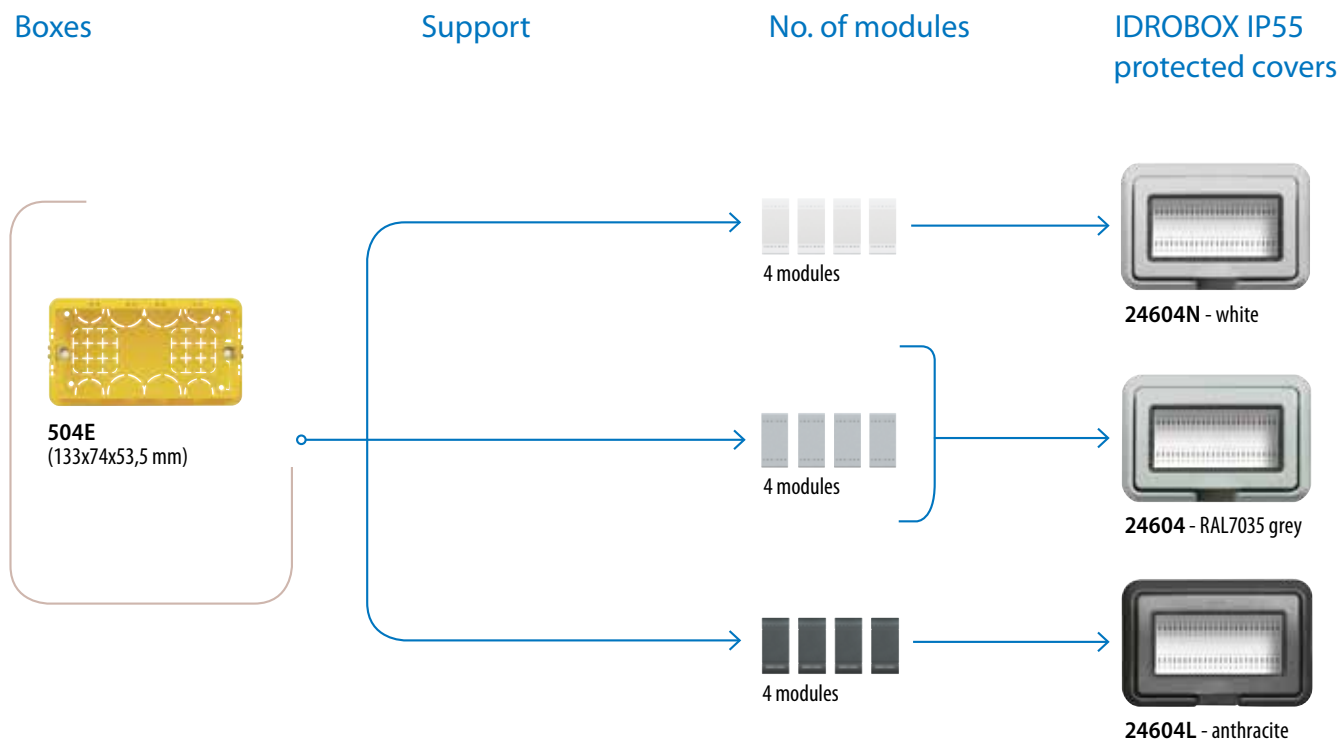

# INSTALLATION IN PROTECTED HOUSINGS

## IP40 AND IP55 IDROBOX PROTECTED HOUSINGS

### IP40 housings

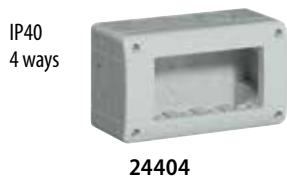
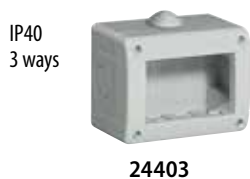
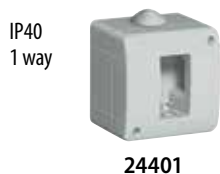

### IP40 housings

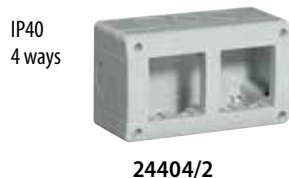

### IP55 housings

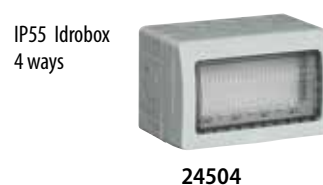







# INSTALLATION IN PROTECTED HOUSINGS AND OTHER







**25700**

**25700F/16**  
**25700F/20**

**150560F**  
 Cutter for raised floor

**150560SB**  
 Box for cement floors

Item	ACCESSORIES FOR IP40 - IP55 HOUSINGS	
○ 25700		flexible cable entry gland Ø 5 to 14-16-20 mm – IP55
○ 25700F/16		quick-coupling pipe gland IP55 for pipes Ø 16 mm
○ 25700F/20		quick-coupling pipe gland IP55 for pipes Ø 20 mm
○ 25701		horizontal partition
○ 25701V		vertical partition
○ 25702		internal terminal for earth connection

Item	WIRING ACCESSORIES - FLOOR BOXES	
		<p>These floor boxes were planned for being equipped with 1 or 2 module devices of the wiring accessories series LIVINGLIGHT.</p> <p>Thanks to the cover with automatic shutting and hinge made of caoutchouc, they allow a very good protection degree (IP24-7).</p> <p>There are two finishes that can be stepped on: inox steel and brass, both of them particularly polished and which can carry a max. split up weight of 500 kg.</p> <p>By means of two specific boxes, the installation can be made in cement floors (with a min. depth of 50 mm) or in raised technical floors (with a min. depth of 60 mm).</p> <p>Dimensions:</p> <ul style="list-style-type: none"> <li>– ext. diameter 100 mm</li> <li>– protrusion from the floor max. 4.5 mm</li> </ul>
○ 150560AC		2 module column, inox
○ 150560OT		2 module column, brass
○ 150560SB		box for cement
○ 150560S		underfloor flush mounted box
○ 150560F		cutter diam. 86 mm