

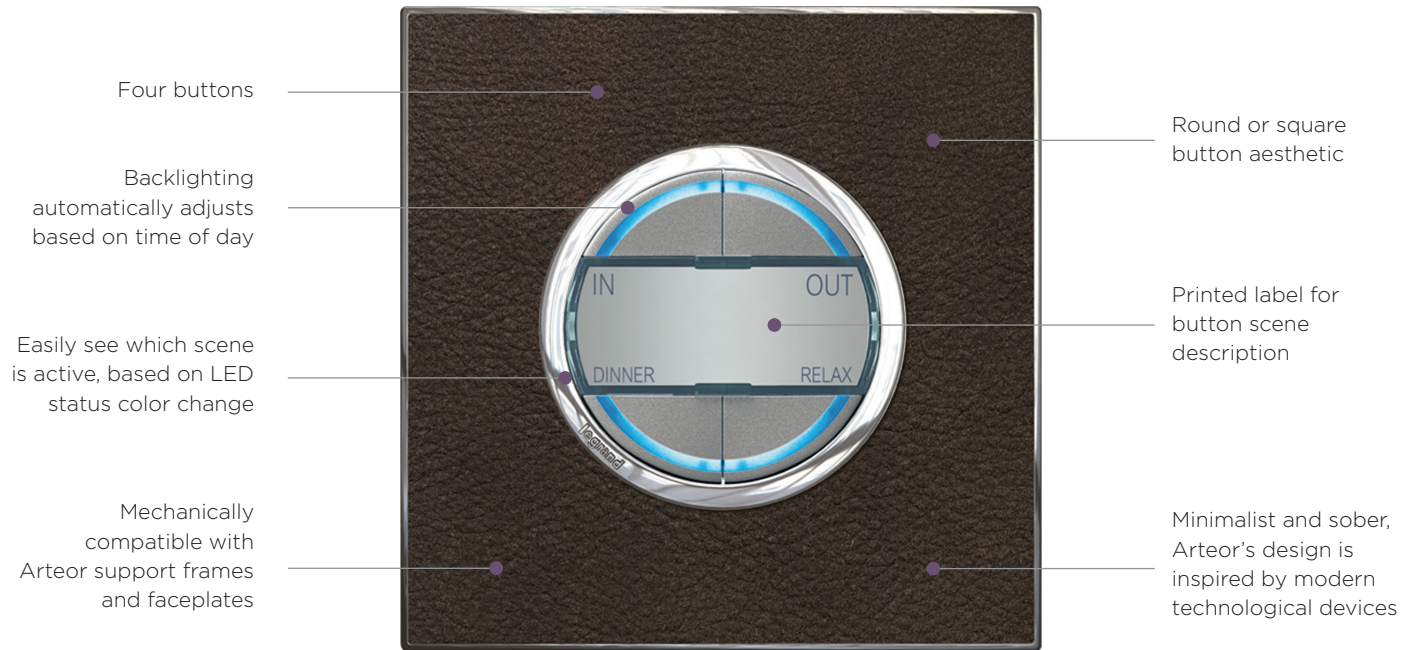

# ARTEOR - VANTAGE LOW-VOLTAGE KEYPAD

*user interfaces*

**KSS14AR / KSR14AR**



## *product overview*

### **description**

Vantage™ now offers a keypad engine that easily snaps in the Legrand® Arteor™ line of faceplates. Arteor takes Vantage technology to a fully compliant global market and enhances the range of international design options. Arteor keypad stations connect to the InFusion Controller's station bus. The new station has four buttons and supports the auxiliary connection port (new four wire version). Each of the four programmable button's 3-color LEDs may be custom programmed to indicate the status of each button.

### **operation**

Arteor Keypads are designed and programmed through Design Center software (2.3 or higher). Installation is very simple, requiring a proprietary 2-wire Vantage Station Bus pigtail connection. The Arteor keypad can be mounted into British and European standard electrical boxes.

PROJECT	
LOCATION/TYPE	

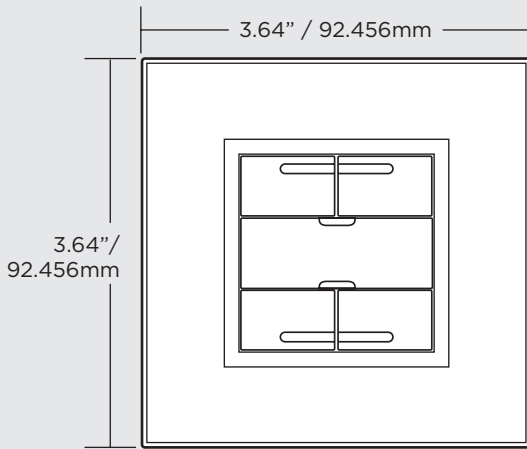

FRONT VIEW

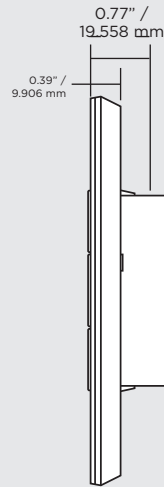

SIDE VIEW

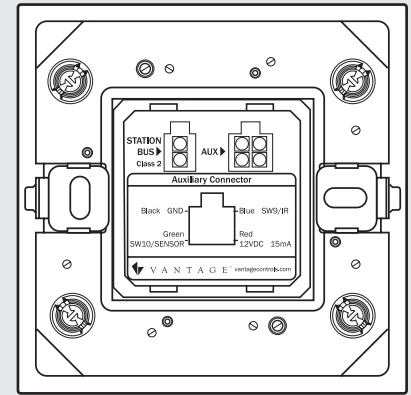

BACK VIEW

## highlights

Buttons have RGB LED color change indication for scene state with intensity based on ambient light levels. This allows for both personalization of the keypad and a clean, minimalist aesthetic. With a full range of RGB adjustable backlighting, the user is able to combine custom LED colors and faceplate styles for a fully customized interface.

## applications

Arteor employs timeless design with a high-tech touch and is ideal for any application. From residential to commercial and small to large projects, as with any other InFusion interface, Arteor can accomplish whatever automation needs you might have. Its minimalist appearance makes it a perfect solution for reduced wall clutter. It can be paired with Equinox touchscreens to fulfill a project's requirements or used alone for smaller projects or those expected to expand.

## features

- Responds instantly to button press regardless of system size
- Accepts multi-event programming on a single button
- Auxiliary connection for motion sensors, wood and metal door contacts, light sensors, etc.
- Uses the standard Vantage two-wire, non-polarized Station Bus
- RGB status indication
- Compatible with 24-volt or 36-volt Station Bus
- Built-in surge suppression
- Available in metal or plastic faceplates
- Communication and power via Station Bus

## specifications

### Dimensions (HWD)

Vantage, engine with buttons	1.77" x 1.77" x 0.84" (92.5mm x 92.5mm x 10mm)
Arteor faceplate	3.64" x 3.64" x 0.39" (92.5mm x 92.5mm)
Arteor mounting plate	3.12" x 3.33" (tabs) (79mm x 85mm) (tabs)

### General Specifications

Model	KSS14AR, KSR14AR
Weight	0.8 oz (22.68)
Voltage	120/240V - 60/50Hz
Addressing	Self addressing through configuration in software
Ambient operating humidity	5 - 95% non-condensing
Ambient operating temperature	32 - 95°F (0 - 35°C)
Surge suppression	Yes
Maximum gangs	Please contact your local Vantage dealer
LED button status	RGB - set custom color in Design Center
Button touch sound	Yes
Button configuration	4-buttons - 2x2
Button colors	Magnesium or white
Wiring connections	2 wire 600V pigtail (included), 4 wire aux. pigtail (order separate)
Power for aux. external devices	15 mA @ 12V DC
Station Bus polarity	Auto-Switching
Station wiring configuration	Daisy-chain/star/branch
Station Bus specification	2C, 16AWG / 1.31mm <sup>2</sup> , twisted, nonshielded, <30pF per foot. Separate a minimum of 12" / 30.5cm from other parallel communication and/or high voltage runs
Power	24V/36V controllers via Station Bus
Station Bus power draw	36V & 24V Controller = 0.75Watts
Addressing	Self addressing through configuration in software
Faceplate finishes	Faceplates and mounting plates hardware available from Legrand
UL, CUL, and CE listed	Yes

### System Compatibility

InFusion

ordering

Ordering Information

CATALOG NO.	DESCRIPTION
<input type="radio"/> KSS14AR-MGNA	Arteor Square 1 Gang, 4-Button Magnesium, Tri-LED Keypad Station
<input type="radio"/> KSS14AR-WHNA	Arteor Square 1 Gang, 4-Button White, Tri-LED Keypad Station
<input type="radio"/> KSR14AR-MGNA	Arteor Round 1 Gang, 4-Button Magnesium, Tri-LED Keypad Station
<input type="radio"/> KSR14AR-WHNA	Arteor Round 1 Gang, 4-Button White, Tri-LED Keypad Station

Ordering Key

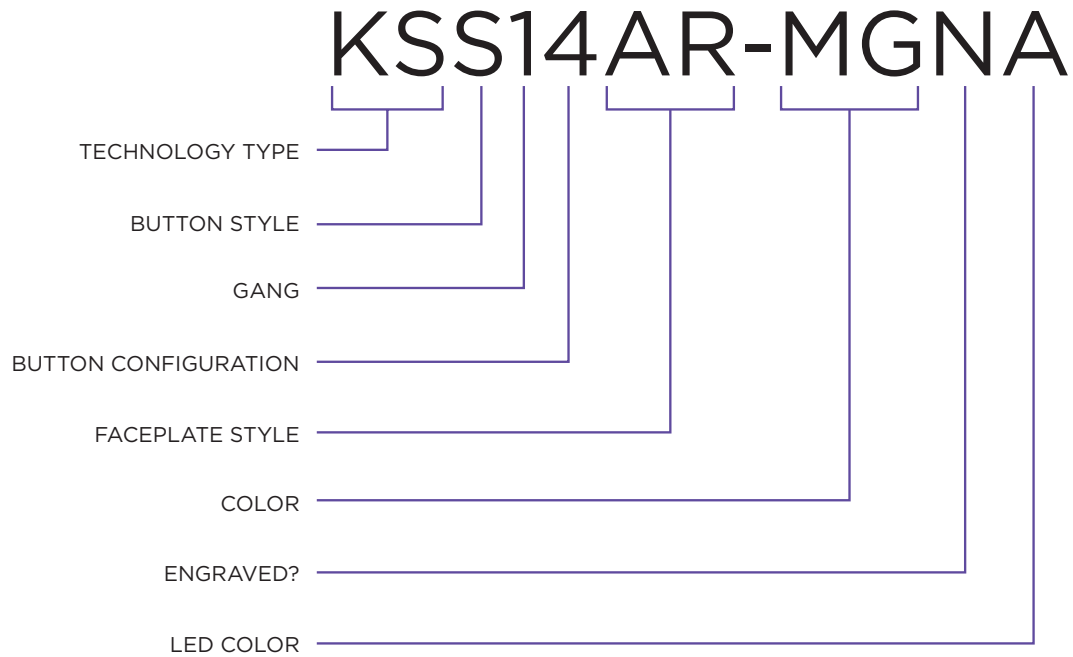

TECHNOLOGY TYPE	GANGS	BUTTON CONFIGURATION*	TRIM/FACEPLATE STYLE*	BUTTON STYLE	BUTTON and FACEPLATE COLOR	ENGRAVED?	LED STATUS COLOR
<input type="radio"/> KS = Keypad Station	1 = Single Gang	4 = 4 Button	AR = Arteor	S = Square R = Round	WH = White MG = Magnesium	Y = Yes N = No	A = Tri-Color "ALL"

[ORDER HERE >](#)

### Keypad Station

---



Arteor LV Keypad Station

### Arteor Button Style Configurations

---

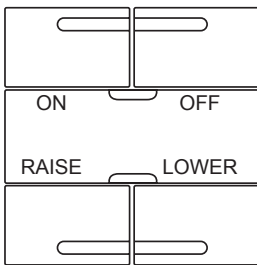

Magnesium Square

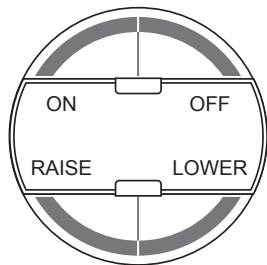

Magnesium Round

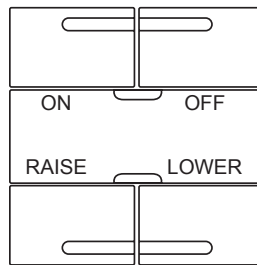

White Square

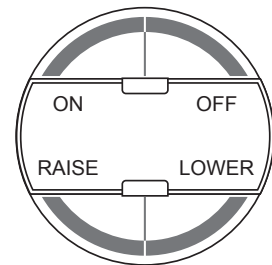

White Round